



- Invitation to subscribe for shares in Industrial Solar Holding Europe AB
Prior to planned listing on Spotlight Stock Market
Industrial Solar Holding Europe AB

www.industrial-solar.se

○ Important information

Motive

This Memorandum has been prepared by the Board of Directors of Industrial Solar Holding Europe AB, with reg. no. 559110-3972, in relation to the offer of and application for listing of additional shares, to be issued by Industrial Solar Holding Europe AB on Spotlight Stock Market.

Definitions

The following definitions apply in this Memorandum, unless otherwise specified: "The Company" and "Industrial Solar" refer to Industrial Solar Holding Europe AB, reg. no. 559110-3972. "Euroclear" refers to Euroclear Sweden AB, Corporate Identity Number 556112-8074. "Spotlight Stock Market" and "Spotlight" refer to ATS Finans AB, Corporate Identity Number 556736-8195, with the auxiliary trade name Spotlight Stock Market.

Memorandum

The Company's offering and this Memorandum are not subject to the Swedish Financial Supervisory Authority's prospectus rules, and this document has not been reviewed or approved by the Swedish Financial Supervisory Authority.

This document has been reviewed and approved by Spotlight Stock Market. However, the approval of Spotlight Stock Market should not be regarded as a guarantee that the factual information in this document is correct or fully disclosed.

Dispute

This Memorandum is governed by Swedish law. The courts of Sweden have exclusive jurisdiction to settle any dispute arising out of or in connection with this Memorandum.

Distribution areas

In several countries, particularly the US, Canada, Hong Kong, Japan, Australia and South Africa, distribution of this Memorandum may be subject to restrictions. In conformity therewith, this Memorandum may not be distributed or published in any jurisdiction unless this is done in accordance with applicable rules and legislation.

Cautionary note regarding forward-looking statements

Statements in this document regarding the external environment and future circumstances reflect the Board of Directors' present view of future events and financial developments. Future-oriented statements express only those assessments and assumptions made by the Board of Directors as of the date of the Memorandum. These statements are based on a thorough consideration of present and anticipated future developments, but readers are advised to note that these statements, like all forecasts for the future, are associated with a degree of uncertainty. The Board of Directors is responsible for this document and has taken all reasonable measures to ensure that the information presented is accurate and complete and that no information has been excluded which could impact the impression of the Company created by the document.

Availability

The Memorandum is available from the Company's website (<https://www.industrial-solar.se/>) and from Spotlight's website (<https://spotlightstockmarket.com/>).

○ Table of contents

<i>Important information</i>	2
<i>Glossary</i>	6
<i>Risk factors</i>	7
<i>Offer to subscribe for shares in Industrial Solar</i>	10
<i>Background</i>	11
<i>A word from the CEO, Christian Zahler</i>	13
<i>Terms and Conditions</i>	14
<i>Market Description</i>	17
<i>Business Description</i>	20
<i>Company History and Sample Projects</i>	26
<i>Board of Directors, senior executives and auditor</i>	28
<i>Financial Overview</i>	35
<i>Comments on the financial overview</i>	46
<i>Share capital and ownership structure</i>	48
<i>Legal matters and supplementary information</i>	50

Information regarding Industrial Solar

Industrial Solar is a German engineering company with expertise within solar heating systems. The Company offers full service solutions to industry customers that have a vast demand for heat generation in their production processes. Industrial Solar offers services and products for each step of the process when a customer wants to convert to solar heating or integrate solar heating into its existing energy systems. Hence, Industrial Solar has the necessary knowledge, know-how and network to deliver solar heating systems from the initial engineering report to procurement, assembly, installation, and after services.

Industrial Solar was founded in 2008 with strong ties to the renowned "Fraunhofer Institute for Solar Energy Systems" as a developer of a solar heating product. The company developed and started to market a so called "Fresnel collector" and the surrounding technology to this collector. However, after some successful customer installations the Company realized that they had the necessary know-how and experience to become a full service, "one-stop-shop", turnkey solution provider and the business model changed accordingly. Today the Company has delivered several turnkey projects to customers all over the world (see examples in the section "Company History and Sample projects").

The offering in brief

Issue price	SEK 6.20 per share
Subscription period	14 th of November to 4 th of December 2018
Record date for subscription rights	12 th of November 2018
Number of new shares	Maximum 2,540,527 newly issued shares in rights issue and maximum 254,052 additional shares in the event of oversubscription.
Pre-money valuation	Approximately SEK 31.5m
Subscription rights	Shareholders in the Company receive one (1) subscription right for each (1) share held. Two (2) subscription rights are required in order to subscribe for one (1) new share.
Trading in subscription rights and interim shares	Since the Company has not been previously listed, no organised trading in subscription rights or paid subscription shares ("BTA") will occur.
Oversubscription	In addition to the preferential rights issue, the Board of Directors may, in the event of oversubscription, decide on a targeted issue of a maximum of 254,052 newly issued shares. The oversubscription issue will be carried out in order to increase the number of shareholders.
Proceeds	The rights issue will provide Industrial Solar with maximum SEK 15.8 million. The oversubscription issue will provide Industrial Solar with a maximum of SEK 1.6 million.
Marketplace	Estimated first day of trading on Spotlight is 15 th of January 2019

Share information

ISIN code	SE0011762517
FISN code	INDUSTSOLA/SH
CFI code	ESVUFR
Ticker symbol	ISHE

Company information

Legal name	Industrial Solar Holding Europe AB
Registration number	559110-3972
LEI code	549300HMLQ707POBTP63

○ Glossary

“Thermal energy” is a term that can refer to several different thermodynamic quantities – here it refers to heat or sensible heat.

“Solar thermal energy” or **“Solar process heat”** refers to the heat generated from harnessing solar energy. Solar thermal technologies convert solar radiation to heat. This solar heat can be used for various applications such as industrial production processes and solar cooling.

“Fresnel solar collector” or **“Fresnel collector”** refers to a type of concentrating solar thermal collector that focuses solar radiation, reflected by several rows of single-axis tracked mirrors onto a stationary receiver. Linear Fresnel reflectors use long, thin segments of mirrors to focus sunlight onto a fixed absorber located at a common focal point of the reflectors. These mirrors are capable of concentrating the sun’s energy to approximately 30 times its normal intensity. This concentrated energy is transferred through the absorber into some thermal fluid.

“Turnkey solution” refers to a type of system built end-to-end for a customer that can be easily implemented into a current business process. It is immediately ready to use upon implementation and is designed to fulfill a certain process such as manufacturing.

○ Risk factors

The Company's operations and the sectors in which it operates are subject to a number of risks that are completely or partly outside of its control and which could materially adversely impact the Company's business, financial condition, operating results and prospects. The risk factors listed below should not be construed as exhaustive, nor are these risk factors ranked according to degree of importance. The Company's business, operating results or financial position may also be materially adversely affected by other risks and uncertainties which are currently unknown to the Company, or which are currently not viewed as material.

Risks related to the issuer and industry

An investment in shares or equity-related securities is always associated with a certain level of risk. A number of factors beyond Industrial Solar's control, as well as a number of factors whose effects the Company may influence through its own actions, may adversely affect the Company's operations, earnings and financial position, which may reduce the value of the Company's shares and cause a shareholder to lose all or part of their invested capital. In assessing the likely course of Industrial Solar's future development, it is therefore important to take into account the risks related to the Company's operations. For obvious reasons, not all risk factors can be described in this section, so a comprehensive evaluation must also include other information in this Memorandum as well as a general assessment. Below are the risks and uncertainties considered to be important for Industrial Solar's future development. The risks are not ranked and the list is not considered complete. Further risks and uncertainties that the Company has not yet identified could also develop into factors that may affect the Company's operations and future development.

Dependence on key personnel

The business is dependent on the ability to recruit, develop and retain qualified employees. There is always a risk that the Company will be unable to offer all key staff satisfactory conditions to compete with those offered by other companies in the industry or related industries. Since the company does not have any patents or patents pending, it depends on the know-how and knowledge of its employees. If key employees leave the company and their know-how is not documented or shared with colleagues properly, the Company might not be able to continue existing development efforts or/and ongoing projects. To replace such employee in due time could cause a delay of respective projects and thus induce increased costs and reduce margins. If key employees leave or cannot be employed in the Company, it may have a negative impact on the business.

Costs through inventions by employees

An employee invention is a patentable or eligible invention that an employee has made as part of their official duties. According to the German law on employee inventions, the employer is in principle entitled to own the rights to the invention. In return for the transfer of an invention, the employee has the right to equitable remuneration, unless they are expressly employed for inventing and paid accordingly. The amount of the remuneration is determined according to the German patent law and relates to the benefit that the company derives from the invention. This benefit can be determined using the methodology of licence analogy preferred by the German Supreme Court (OGH), by determining the internal benefit or by estimating it.

There is a risk that costs may arise due to these circumstances, and that any such costs may adversely affect the Company's operations, financial position and earnings.

Agreements governed by foreign law

The Company's operations including most of its agreements are governed by German law. A dispute concerning such agreements (such as employment agreements, supply agreements, customer agreements and co-operation agreements) therefore has to be settled through litigation abroad, often by involving German legal advisers. There is a risk that costs may arise due to these circumstances, and that any such costs may adversely affect the Company's operations, financial position and earnings.

Ability to handle growth

As the organisation grows, effective planning and management processes need to be developed. If the Company fails to handle a rapid growth rate, there is a risk that this could have a negative impact on operations and profitability.

Early stage of development

Industrial Solar has not yet achieved a turnover that generates a positive cash flow or profits. There is a risk that it will take a long time before an operating surplus occurs or that profitability will never be achieved. There is also a risk that the Company will misjudge the products' commercial viability, or the prices the market is willing to pay. Should any of these three risks be realised, it may result in the dismantling of all or part of the business, insolvency or bankruptcy, whereby the invested capital would be lost in whole or in part.

Suppliers and production

Industrial Solar acts in close cooperation with its subcontractors. There is a risk that shortcomings in these functions could lead to unforeseen expense or loss of income, with a negative impact on the Company's operating result. Furthermore, the Company has not yet established supplier contacts to such an extent that all of the components can be procured from more than one source. There is also a risk that the Company's suppliers could choose to terminate their collaboration, which would adversely affect the business.

Competition

Only a few companies in the world provide the type of turn-key solar thermal installations that Industrial Solar delivers. However, energy supply to industry is a highly competitive market. There is a risk that increased competition from market participants with, in many cases, considerably greater financial resources may lead to reduced growth opportunities or other adverse effects on the Company's operations.

Earning ability and future capital needs

There is a risk that, whether in the short term or the long term, the Company will not generate sufficient funds to finance continued operation. There is a risk that the Company will not be able to obtain the required funding or that it will not be possible to obtain such funding on, for existing shareholders, favourable terms. Failure to obtain additional funding at certain times would mean that the Company would have to postpone or terminate operations.

Uncertainty about future market trends

It cannot be ruled out that markets could develop in an unfavourable direction for the Company due to changed macroeconomic factors, falling energy prices, technological developments, new regulations or other environmental factors. Such events entail the risk of adverse effects on the Company's profitability and financial position.

Credit

In connection with the delivery of solar thermal collectors and turnkey solar thermal solutions to international markets, order volumes are relatively large. Should a customer fail to fulfil the agreed payment plan, the Company's liquidity will be adversely affected, temporarily or permanently, with the risk of capital shortage as a possible consequence.

Legal and political risks

The Company currently is and will remain active in markets and sectors which in many cases are characterized by a high degree of political intervention and/or legislation and regulations of various kinds. There is therefore a risk that changes in laws, regulations or the political situations in different markets where the Company and/or its customers operate may affect the Company's profitability and prospects.

Changes in exchange rates

The Company is active in an international market where prices for both material and components as well as the prices obtained for finished products in many cases are dependent on the performance of the Swedish krona or the euro against a number of foreign currencies. There is a risk that exchange rate fluctuations that increase the value of the Swedish krona

or the euro will adversely affect the Company's earnings in connection with transactions with foreign customers.

Risks related to the securities

Trade on Spotlight

The Company's shares are traded at Spotlight Stock Market (formerly Aktietorget), which is an MTF (Multilateral Trading Facility). A marketplace of this kind does not impose such stringent demands on the Company regarding disclosure, transparency or corporate governance, compared to the requirements imposed on companies whose shares are listed on a regulated market. Spotlight has introduced most of the regulated market rules, but investments in a company whose shares are traded on an MTF should nevertheless be considered more risky than an investment in a listed company.

Owner with great influence

A concentration of control of the Company may be detrimental to shareholders other than majority shareholders. The ownership structure may change over time. It cannot be ruled out that the current composition of dominant owners will change over time, with the risk that the Company's business orientation may deviate from what is currently stated by the Company's Board.

Liquidity in trading

Liquidity in trading with the Company's shares may be limited for shorter or longer periods. This can exacerbate fluctuations in the trading price. Limited liquidity may make it difficult for owners to sell their shares.

Stock price fluctuations

The stock price may fluctuate as a result of, for example, profit variations in the Company's quarterly reports, the general economic situation and changes in the stock markets interest for the Company and its shares. Therefore, the share price may be affected by factors that are wholly or partly beyond the Company's control. An investment in Industrial Solar shares should be preceded by a careful analysis of the Company, its competitors and the broader environment,

general information about the industry, the general economic situation and other relevant information.

Dividend

Since its foundation, the Company has not paid any dividends to the shareholders. It is the management's intention to use earnings generated in the next few years to develop the Company's operations and consolidate its position in the market. It is the Annual General Meeting that decides on dividends to shareholders based on the prevailing conditions for the business. There is a risk that dividends will not be paid in the next few years. The opportunities for return on an investment in the Company's shares therefore consist primarily in the possibility of an increasing share price.

Unsecured subscriptions

In connection with the forthcoming new issue, Industrial Solar has received underwriting guarantees from two companies, corresponding to the entire issue amount. Industrial Solar has not requested that blocked bank funds or other collateral be put in place for the fulfilment of these commitments. There is thus a risk that any or all of the parties who have underwriting guarantees may not fulfil their obligations, which could adversely affect the Company's opportunities to receive the required funds.

○ Offer to subscribe for shares in Industrial Solar

On 5th of November 2018, the Board of Directors of Industrial Solar decided, pursuant to an authorisation from the General Meeting of 26 September 2018, to carry out a new issue of shares with a preferential right for existing shareholders.

Offered securities

The offer refers to purchase of new common stock shares issued in Industrial Solar. The subscription price is SEK 6.20 per share.

Subscription period

Shares must be subscribed for during the period from 14th of November to 4th of December 2018.

Preferential subscription right

Any person who, on the record date of 12th of November 2018, is registered as a shareholder in the Company has a preferential right to subscribe for shares. Shareholders in the Company receive one (1) subscription right for each one (1) share held. Two (2) subscription rights are required in order to subscribe for one (1) new share. The rights issue comprises 2,540,527 newly issued shares.

Oversubscription

The Company has committed to issue a maximum of 254,052 additional shares, corresponding to a maximum of ten percent of the number of shares in the offering, and three percent of the total maximum number of shares in the Company after the offering, at a price of SEK 6.20, if the offering is oversubscribed. The oversubscription issue may only be utilised for the purpose of covering any oversubscription to the offering. The oversubscription issue is carried out for the purpose of increasing the number of shareholders.

Dilution

Share capital in the Company may increase through the rights issue by not more than SEK 250,000, from SEK 500,000 to not more than SEK 750,000, and the number of shares in the Company may increase by not more than 2,540,527 shares, from 5,081,055 shares to 7,621,582 shares. Shareholders who choose not to subscribe for shares in the rights issue will sustain a dilutive effect of a preliminary 33 percent of total voting power in the Company (provided that the rights issue is fully subscribed). Shareholders have the option to sell their subscription rights to obtain compensation for the dilution. If the rights issue and the oversubscription issue are fully subscribed, the total number of shares in the Company will increase by 2,794,579 shares, corresponding to approximately 35 percent of the total number of shares and votes in the Company following completion of the offering.

Subscription commitments and underwriting guarantees

Underwriting guarantees have been provided equivalent to 100 percent of the rights issue. The companies Fastighetsbolag PONORD AB and Eniara AB (owned by the Chairman in Industrial Solar Joakim Byström) have undertaken to take up their preferential subscription rights in the rights issue and subscribe for additional shares in the event that not all shares are subscribed for up to 100 percent of the issued shares. Compensation corresponding to 1,5% of the additional shares (not their preferential subscription rights) will be paid for the underwriting guarantees. In respect of the underwriting guarantees provided, the companies who entered into commitments can be contacted through the Company.

Issue costs

The Company's issue-related costs are expected to amount to approximately SEK 700,000. The issue costs are attributable to the preparation of the Memorandum, issue administration and marketing expenses.

Future capital needs

The proceeds from the current issue are estimated to last for at least 12 months. The Company plans to carry out an additional capital increase after this period where the proceeds will be used for expansion or technology developments. However, the timing and size of such capital increase will depend on circumstances such as profitability, business opportunities and market situation.

○ Background

Industrial Solar is a German engineering company with expertise within solar heating systems. The Company offers full service solutions to industry customers that have a vast demand for heat generation in their production processes. Industrial Solar offers services and products for each step of the process when a customer wants to convert to solar heating or integrate solar heating into its existing energy systems. In such processes, Industrial Solar begins by analysing the customer's situation regarding the current energy demand, existing system, location, the venue etc. and from this presents an engineering report. The engineering reports include a solution to the customer's request, as well as indications on cost, carbon emission savings and the customers return on investment. The engineering report constitutes the basis for further decisions and actions of the customer. Having received the order the Company provides detailed engineering and commences the procurement of the needed components, material and work force, such as welders, in the customer's local area. The Company then, together with the hired work force, assembles and installs the system at the customer site. When the system is up and running, either individually or integrated into the customer's old energy system, the Company services the system when needed. Hence, Industrial Solar offers a turnkey solution to customers meaning that the Company takes full responsibility of the project from the initial analysis to functioning system and after services.

Industrial Solar was founded in 2008 with strong ties to the renowned "Fraunhofer Institute for Solar Energy Systems" as a developer of a solar heating product. The company developed and started to market a so called "Fresnel collector" and the surrounding technology to this collector. A Fresnel collector is a linear concentrating solar thermal collector with mirror rows following the sun to direct the irradiation onto a central absorber tube, through which a heat carrier fluid circulates. In other words, a field of tracked mirrors directs the rays from the sun onto a secondary mirror, which concentrates the rays onto an absorber tube, where the solar radiation is converted to heat. This technology is customized for customers with a large need of energy, such as industrial factories. These solar process heat systems can generate temperatures of up to 400 °C in a power range from 500 kW to 20 MW. In the years following the foundation of the Company, Industrial Solar focused solely on selling their developed solar collector, the "LF-11 Fresnel collector". However, after some successful customer installations, the Company realized that they had the necessary know-how and experience to become a full service, "one-stop-shop", turnkey solution provider and the business model changed accordingly. The LF-11 collector still plays a key role in Industrial Solar's business model, but the Company now has the necessary engineering competencies to also work with other solar heating technologies if the circumstances requires.

Today the Company has delivered several turnkey projects to customers all over the world (see examples in the section "Company History and Sample projects").

In 2015 Industrial Solar signed a convertible loan with a strategic Chinese investor. The loan agreement contained the option to become a majority shareholder through conversion of the loan combined with an additional investment. At the time the loan was due and the option expired, the investor was not able to further invest, due to financial difficulties related to the investors core business. Nevertheless, Industrial Solar entered negotiations with yet a new potential strategic investor. Unfortunately, at the end of April 2018, a conflict of interest between these two investors based on competing business units emerged that could not be resolved, and Industrial Solar GmbH had to file for insolvency in early May 2018.

Absolicon Solar Collectors AB recognised this opportunity and became the new strategic investor. Absolicon then distributed these shares to the shareholders its shareholders. The "new" company signed an asset transfer deal of EUR 45,000.00 (paid by Absolicon) with the insolvency administrator, which included production, installation, tools and testing equipment, office equipment, IT, software and drawings. In addition, the complete staff of the old company was taken on. The asset deal also included the name rights, so the new company could continue to operate as Industrial Solar GmbH. Industrial Solar Holding Europa AB was then able to re-initiate business activities in early August 2018 to the same extent as prior to the insolvency.

Until the current issue, the operations of Industrial Solar have been financed by loans from Absolicon. The loans amount to MSEK 2.3 and are, according to the board, favourable as they carry an interest rate of 1 percent and the terms do not require the Company to pay back using the capital from the current issue, but from future profits on operations, or by equity.

With the insolvency situation solved, Industrial Solar has regained focus on the core business and development of the Company. The board of director's was and is confident in Industrial Solar's business model and sees an opportunity to further develop it with the proceeds from the current issue. Hence, the proceeds from the current issue will, in full, be used for developing the business and products. More specifically, the company will use the proceeds to develop the Fresnel collector and the surrounding technology. Although the Fresnel collector is a ready-to-sell product, the development will focus on reduction of production costs and simplification of the installation process. The Company estimates that these developments will reduce the procurement costs by 30 percent. Accordingly, the Company estimates that the

measures mentioned will increase the margins in each project and at the same time decrease the time for the customers to achieve a positive return on investment.

The proceeds from the current issue will also be used to develop a prefabricated container that contains the peripheral components of the solar collector field. Peripheral components are the components that are not directly related to the solar collector, but needed in order to install the system at the customer site. Such components include pumps, pressurization system, valves, sensors and controls. A container of peripheral components will allow Industrial Solar to more efficiently integrate solar process heat systems into existing industrial energy systems. This will reduce the time of installation as well as the cost of installation and, in turn, enable Industrial Solar to deliver more projects as their capacity increase. The Company estimates that such container will reduce the time consumed installing the integration system by up to 50 percent.

The Company estimates that these projects will be finished and commercialized by the end of 2019.

Industrial Solar also intends to use a portion of the proceeds for international marketing and sales purposes. The Company will initially increase the international marketing budget, but believes that additional sales and marketing personnel are needed within the foreseeable future.

The proceeds from the current issue, which is fully underwritten by existing shareholders, will hence amount to approximately SEK 16.6m after issue-related costs. The proceeds will be used in the following order:

- 30% Further development of the Fresnel collector
- 35% Integration system (BoP) development
- 20% International sales and marketing
- 15% Project development

The Board of Directors
Freiburg, 13th of November 2018
Industrial Solar Holding Europe AB

○ A word from the CEO, Christian Zahler

We have the ultimate clean source of heat for industry. We are well positioned for technology and market leadership. With your support we can unleash the huge market potential for solar process heat systems!

Cleantech has already been an incredibly dynamic market in the last decade – and it is still gathering momentum. Besides technological innovation, it needs entrepreneurial companies to establish these solutions in the market. I already worked on solar research and development projects as well as in other companies before joining Industrial Solar in 2008 – greening the industrial heat supply is an exciting task.

Having started to work on solar thermal collectors in the 1990s, I have accompanied the development of the Fresnel collector for more than two decades, from the first laboratory tests to commercial operation. With extensive know-how and expertise in products, solutions and customer demands, Industrial Solar has already installed the most Fresnel collector solutions for industrial process heat in the world.

As solar thermal energy will in future cover a major share of industrial heat demand, Industrial Solar has developed a technology explicitly to address this huge demand – the LF-11 Fresnel collector. This is a concentrating solar thermal collector whose uniaxially tracked mirror rows direct the irradiation onto a central absorber tube, through which the heat carrier circulates. The features of the LF-11 are optimised for industrial applications.

More than a dozen of the collectors have already been installed, and are continuously optimised. The commercial operation of the collector in industry proves its suitability and our system design expertise.

We are thus well positioned to take a large share of this developing market with an extremely large market potential. Our international team of 14 highly skilled and experienced experts is fully committed to becoming a major player and accelerating our product development for this market. The board of Absolicon Solar Collectors AB recognised the versatile synergies between both companies and took the unique opportunity to finance the relaunch of Industrial Solar.

In order to take advantage of these opportunities, and to further reduce collector and systems costs while developing relevant projects, the Board of Industrial Solar has decided to implement the current offering.

Sincerely,

Christian Zahler
CEO Industrial Solar Holding Europe AB

○ Terms and Conditions

On 5th of November 2018, the Board of Directors of Industrial Solar Holding Europe AB (corporate ID no. 559110-3972) decided, pursuant to an authorisation from the Annual General Meeting of 26 September 2018, to carry out a new issue of shares with a preferential right for existing shareholders. The issue consists of a maximum of 2,540,527 shares and will bring SEK 15,751,267 into the Company if subscribed for in full. In addition to this preferential rights issue, the Board of Directors may, in the event of oversubscription, decide on a targeted issue of 10 percent, a maximum of 254,052 shares. The oversubscription issue will be carried out in order to increase the number of shareholders.

Record date

The record date at Euroclear Sweden AB ("Euroclear") for determining who is to receive subscription rights in the issue is 12th of November 2018. The last day for trading in the Company's shares including the right to receive subscription rights is 8th of November 2018. The first day for trading in the Company's shares excluding the right to receive subscription rights is 9th of November 2018.

Subscription period

Shares must be subscribed for during the period from 14th of November to 4th of December 2018. The Board of Directors has a right to extend the subscription period. It has no right to discontinue the issue after the subscription period has begun.

Issue price

The issue price is SEK 6.20 per share. No brokerage fees will be charged.

Preferential subscription rights

Shareholders in the Company receive one (1) subscription right for each (1) share held. Two (2) subscription rights are required in order to subscribe for one (1) new share. After the expiry of the subscription period, unused subscription rights will be invalid and will be derecognised from the securities account without any specific notification from Euroclear.

Trading in subscription rights

No trading in subscription rights will take place.

Paid subscription shares ("BTA")

Subscription by payment is registered with Euroclear as soon as possible, which normally means a few banking days after payment. The subscriber then receives a securities notification with confirmation that BTA have been recorded in the securities account. Subscription shares are referred to as BTA until the new issue has been registered at Bolagsverket [the Swedish Companies Registration Office].

Partial registration of the rights issue

According to the Swedish Companies Act, under certain conditions, part of the rights issue may be registered with the Swedish Companies Registration Office. If this option is used, several series of BTA will be issued, the first series being called "BTA 1" in the Euroclear system. BTA 1 will be converted into Shares as soon as a first partial registration has been made. A second series of BTA, "BTA 2" will be issued for those subscriptions that are not included in the first partial registration. BTA 2 is converted into Shares once the Rights Issue has been finally registered with the Swedish Companies Registration Office.

Listing on spotlight

The shares of the Company will be traded on Spotlight. The shares will be traded under the ticker symbol ISHE and the ISIN is SE0011762517.

Preferential subscription right

Any person who, on the record date of 12th of November 2018, is registered as a shareholder in the Company has a preferential right to subscribe for one (1) new share for two (2) existing shares.

Directly registered shareholders, possession of a securities account

The shareholders or representatives of shareholders who, on the record date, are entered in the share register kept by Euroclear on behalf of the Company receive a pre-printed issue statement with an attached payment notice, a special application form and an application form for subscription without subscription rights. No securities notification regarding registration of subscription rights in a securities account is sent.

A person included in the list of pledgees and guardians kept in connection with the share register does not receive an issue statement, but is notified separately.

Nominee-registered shareholders, possession of a custody account

Shareholders whose holdings of shares in the Company are nominee-registered at a bank or other nominee receive no issue statement. Subscription and payment will instead take place according to instructions from the nominee.

Subscription with subscription rights, directly registered shareholders

Subscription will take place by means of a payment using the specified bank giro no later than 4th of December 2018 in accordance with either of the following two options.

1) Pre-printed payment notice; issue statement

Used if all subscription rights received are to be used. Subscription takes place by payment of the pre-printed

payment notice. Please note that no further action is required for subscription and that the subscription is binding.

2) Special application form

Used if a different number of subscription rights is to be used than is stated on the pre-printed issue statement, e.g. if subscription rights have been purchased or sold. Subscription takes place when both the special application form and the payment have been received by Eminova Fondkommission. The reference for payment is the application form number. Incomplete or incorrectly completed application forms may be disregarded. The application form can be sent by ordinary post (NOT REGISTERED POST), by email or by fax. Please note that the subscription is binding.

A special application form can be obtained from Eminova Fondkommission AB, tel. +46 (0)8-684 211 00, fax +46 (0)8-684 211 29, email info@eminova.se.

Shareholders domiciled outside sweden

Directly registered shareholders entitled to subscribe who are domiciled outside sweden

Directly registered shareholders entitled to subscribe who are not domiciled in Sweden and who cannot use the pre-printed payment notice (the issue statement) can pay in SEK via SWIFT, using the account details given below. Subscription takes place when both the special application form and the payment have been received by Eminova Fondkommission.

Eminova Fondkommission AB
Biblioteksgatan 3, 3 tr
111 46 Stockholm, Sweden
BIC/SWIFT: NDEASESS
IBAN: SE9230000000032731703768

Shareholders domiciled in certain ineligible jurisdictions

Shareholders domiciled in another country where participation in the new issue is wholly or partly subject to legal restrictions (for example Australia, Canada, Hong Kong, Japan, New Zealand, Singapore, South Africa, Switzerland, the United States) are not entitled to participate in the new issue. These shareholders will not receive subscription rights, an issue statement or any other information regarding the new issue.

Subscription without subscription rights and allocation

An application for subscription for shares without subscription rights must be submitted using the application form entitled "Teckning utan stöd av teckningsrätter" [Subscription without subscription rights], which may

be downloaded from the Company's website www.industrial-solar.se and www.eminova.se. If more than one application form is submitted, only the first one received will be taken into account. Payment must not be made at the time of application! Please note that the application is binding. (Important information on ISK [investment savings accounts], IPS [individual pension savings] and endowment insurance is set out in the section entitled "Miscellaneous".)

If the application relates to subscription in the amount of EUR 15,000.00 (approx. SEK 150,000.00) or more, the application form must be accompanied by a copy of a valid and certified ID document and a KYC. If the application relates to a legal entity, the application form must also be accompanied by a valid registration certificate (not older than three months) showing the authorised signatory.

Notice of allocation of shares is given through remittance of a contract note. Payment must be made by bank giro in accordance with the instructions on the contract note and will not be drawn from the specified securities account or custody account. If payment is not made within the prescribed period, there is a risk that the shares will not be delivered in time before the first trading day. The shares may be transferred to another party. If the selling price for such a transfer is below the price in accordance with the offer, the person who was originally allocated these shares will be liable for all or part of the difference. No notice is sent out to anyone who was not allotted shares.

In the event that not all shares are subscribed for with preferential rights (i.e. with subscription rights), the Board of Directors, will decide on the allocation of shares subscribed for without subscription rights, within the framework of the maximum amount of the issue, whereupon the shares will firstly be allotted to the persons who were shareholders on the record date 12th of November 2018 (and who have specified this on the application form) and, in the event that these cannot be fully allocated, shares will be allocated in proportion to their previous holdings (but not less than 800 shares) and, if this is not possible, by drawing lots, and the shares will secondly be allotted to those who have subscribed for shares in the issue without subscription rights and, in the event that these cannot be fully allocated, the shares will be allocated in proportion to the number of shares (but not less than 800 shares) that each person subscribed for and, if this is not possible, by drawing lots, and, finally, the shares will be allocated to guarantors, being distributed in proportion to established guarantee commitments and, if this is not possible, by drawing lots.

If the issue is oversubscribed and the Board of Directors chooses to make use of the targeted issue, these shares will be allocated in such a way as to increase the number of shareholders. Therefore, shares will primarily be allocated to anyone who was not allotted shares in the rights issue but who has at least 800 shares, corresponding to SEK 4,960.

Miscellaneous

Subscription for shares with or without subscription rights is irrevocable and the subscriber cannot cancel their subscription.

Regarding subscription for isk, ips or endowment insurance

If the custody account or securities account is linked to endowment insurance or an IPS or ISK account, special rules apply for any new subscription of shares. The subscriber must contact their bank/nominee and follow the latter's instructions regarding the procedure for subscription/payment. If the subscription does not take place in the correct manner, the allocated shares cannot be delivered to these types of custody accounts, and the subscriber will be advised to state another account to which the shares can be delivered. The subscription is binding and application forms, once submitted, cannot be revoked. The subscriber is responsible for ensuring that the subscription takes place in such a way that the shares can be delivered to the specified custody account.

Regarding delivery of subscription securities

Incorrect or incomplete information on the application form, the registration procedure at the Swedish Companies Registration Office, late payments from investors, procedures at a nominee bank or custodian institution or other factors beyond Eminova's control can delay the delivery of shares to

the investor's securities account or custody account. Eminova assumes no liability for losses or other consequences that an investor may suffer as a result of the timing of delivery of the shares.

Publication of the outcome of the issue

The outcome of the issue will be published by means of a press release from the Company as soon as possible after the expiry of the subscription period.

Right to receive dividends

The new shares confer an entitlement to receive a dividend for the first time on the record date for dividends that occurs immediately after the new shares have been registered at the Swedish Companies Registration Office.

Share register

The Company's share register with details of shareholders is kept by Euroclear Sweden AB, Box 191, 101 23 Stockholm, Sweden.

Applicable law

The shares are issued under the Swedish Companies Act (2005:551) and are governed by Swedish law. Shareholders' rights with regard to dividends, voting rights, preferential rights for subscription of new shares, etc. are governed by the Company's Articles of Association, which are available on the Company's website, and by the Swedish Companies Act (2005:551).

Important information

Further terms and conditions regarding subscription are stated on the subscription form.

○ Market Description

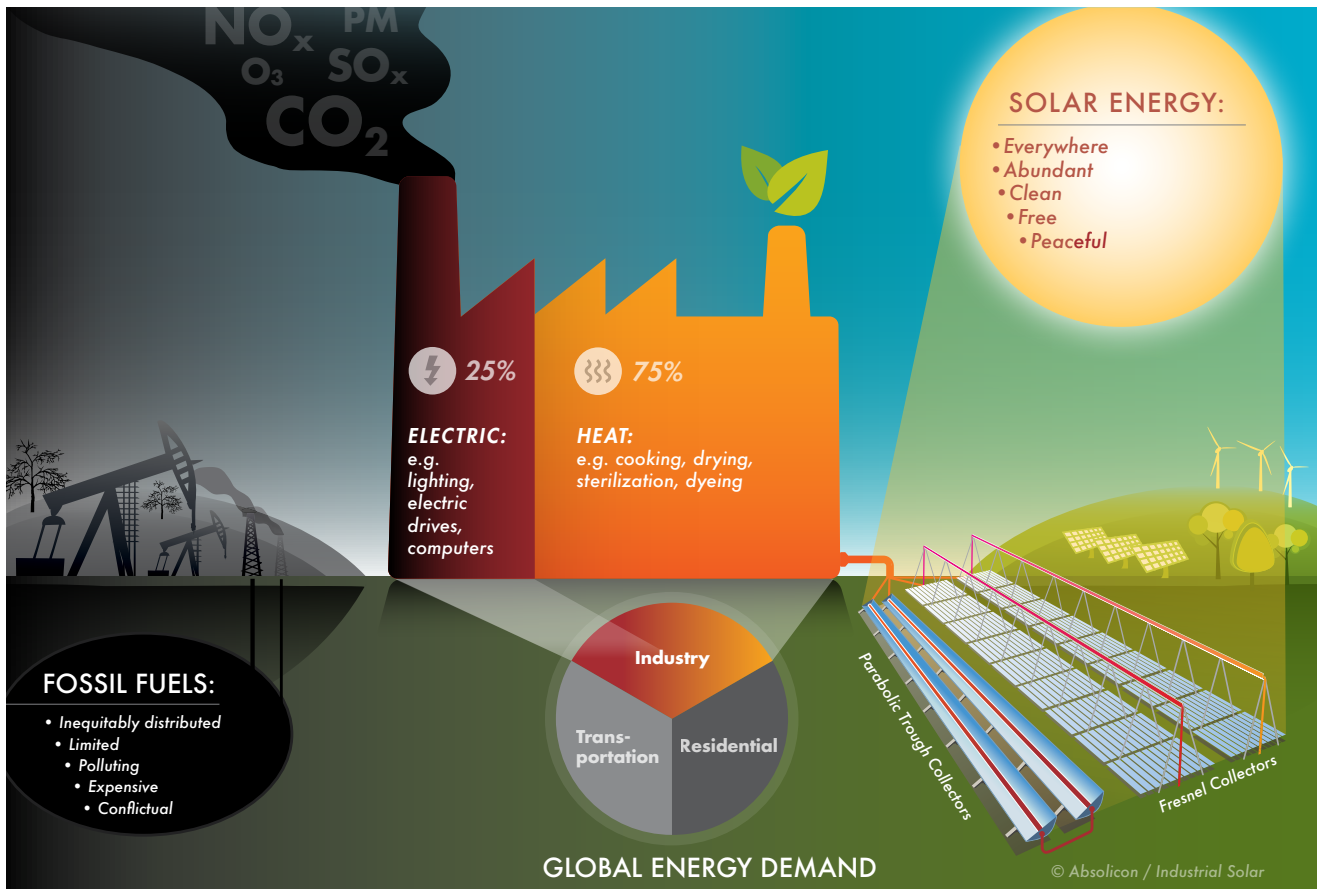

Industrial Energy Demand

Industry is responsible for one third of total final energy consumption, with the major share being used for process heating¹. Since industrial production is expected to grow by almost a factor of 4 by 2050², the growth taking place mainly in non-OECD countries, industrial process heating is of the utmost relevance. However, to date it has hardly been addressed in climate change mitigation measures and accordingly the share of industrial CO₂ emissions is expected to grow from 24 percent (2014) to 44 percent (2050)³. To achieve net zero emissions to stabilise the level of greenhouse gases in the atmosphere, industrial heating is of key importance. The graphic below shows the global energy demand, a significant proportion of which is accounted for by industrial energy and particularly heat. Nowadays most of this heat demand is covered using fossil fuels, which can easily be replaced by solar energy and concentrating solar collectors used to provide process heat at high temperatures.

The industrial heat market is lagging behind in the integration of clean technologies. High-temperature solar heat, meeting industrial standards, was a challenge in the past, but today technological and commercial solutions are available. However, industrial investments are typically based on short-term paybacks, even when long-term returns are high. Therefore, investments in sustainable solutions to fight climate change will play an important role in the coming years.

Investments in Climate Finance

Annual investments in climate finance almost doubled in the last decade, reaching USD 280 billion in 2017⁴. Yet the International Energy Agency (IEA) estimates that to fulfil the Paris Agreement an amount of USD 3.3 trillion is needed in the next 15 years, around an additional USD 160-300 billion per year⁵. Commitments have already been made. The Green Climate Fund, for example, will receive USD 100

1: IEA International Energy Agency (2016) "Key World Energy Trends. Excerpt from: World energy balances"

2: UNIDO (2011) "Renewable Energy in Industrial Applications. An assessment of the 2050 potential"

3: IEA International Energy Agency (2017) "Renewables For Industry"

4: Bloomberg New Energy Finance

5: GGGI Global Green Growth Institute (2016) "Mind the Gap: Bridging the Climate Financing Gap with Innovative Financial Mechanisms". Seoul.

billion annually to support developing countries in climate change adaptation and mitigation⁶. The inflow of investment will also further accelerate the uptake of clean industrial process heat. Despite the enormous number of economically viable applications of renewable energy in emerging markets, it remains challenging to match them with the needs of investors. New financing vehicles are thus expected to emerge which will be suitable for the various stakeholders, especially in non-utility projects like in industry. In addition, the number of blue-chip companies and SMEs committing themselves to zero emissions is constantly growing.

Industry commitment to renewable energy

The struggle for a sustainable use of energy is often perceived as a fight against international corporations and their practices. While they are still responsible for a major share of our carbon footprint, numerous international corporations, like IKEA and H&M, have already committed to using 100 percent renewable energy. These companies come from all sectors and continents and each take a specific look at their role and impact – major insurance companies, for example, have started to limit their investment in or insurance of coal-fired power plants. The pressure on supply chains to adopt sustainable practices is also increasing. At the same time, several corporations have joined forces in initiatives (<http://there100.org/>) to ensure that they have a strong voice in issues of policy. Targets are mainly for 2020 to 2030 and the work is at an early stage. Nonetheless, the results can already be seen as corporations screen and test solutions for larger roll-outs. Japan Tobacco International, for example, has installed the Fresnel collector for solar steam generation in Jordan with the intention of a subsequent roll-out in other plants.

Industrial solar collectors: Short overview of technologies

Solar collectors can supply heat at different temperatures for production processes in a variety of industries.

In the solar thermal industry, there are a number of competing technologies to provide solar heat to industry.

The oldest and most reliably proven technology is the flat-plate solar collector. It consists of a black metal sheet with integrated

water pipes enclosed in a square box with a glass window. This is a common technology to provide domestic hot water and is suitable for temperatures up to 80°C.

In vacuum tubes, very popular in China, the black metal sheet is enclosed in a glass tube and insulated by vacuum inside the tube. These systems are suitable for temperatures up to 90°C and, with back reflectors, up to 120°C. Unfortunately, the pipes tend to leak, and it is difficult to achieve a lifetime longer than 10-12 years.

Flat-plate systems and vacuum tubes are mainly used for domestic hot water. Flat-plate collectors are also used in district heating networks.

For industries that require higher temperatures, there are very few manufacturers who have managed to make systems with a long lifetime and good performance. The two technologies used are parabolic trough collectors and Fresnel collectors.

A parabolic trough collector has a parabolic reflector that focuses the light onto a narrow line in the centre of the reflector on a tube. The reflector is rotated to follow the sun. These systems can be made with a long lifetime and high performance. The PTC produced by Absolicon Solar Collector in Sweden is designed for operating temperatures from 80°C to 160°C.

A Fresnel solar collector, on the other hand, uses a set of mirrors, moving together, to focus the light onto a fixed pipe placed over the mirror area. The technology can provide temperatures up to 400°C.

Alongside these technologies, there are other, more exotic solutions like solar towers, flat vacuum collectors and different solutions with stationary reflectors.

However, while there have been many attempts, there are still only a small number of manufacturers in the world who have managed to make products with the necessary performance, lifetime and durability to meet the demands of industry.

⁶: <https://www.greenclimate.fund/who-we-are/the-climate-challenge#response-description>

The chart below shows the market segments and temperatures needed for different applications in different industrial sectors.

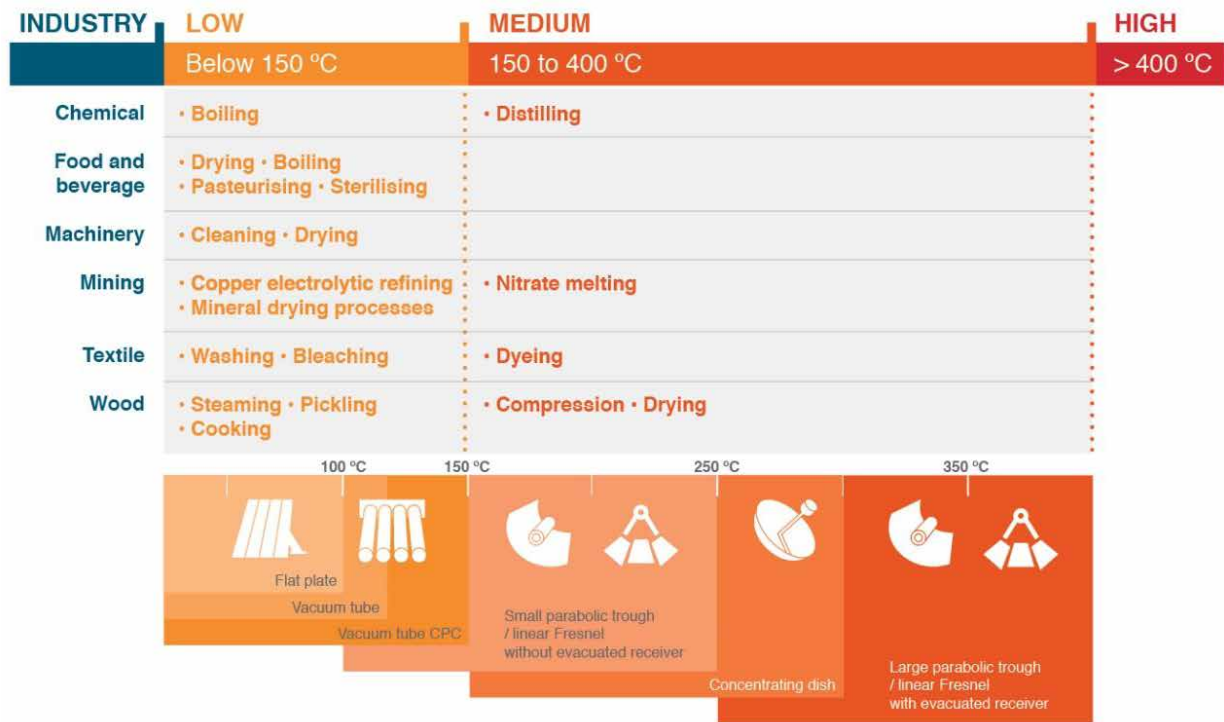

Source: Solar Payback / IEA SHC Task 49

Competitor Analysis

Industrial Solar has a small – but growing – number of competitors worldwide. Most of them are involved in the development and production of parabolic trough collectors and only a few work with Fresnel technology. Industrial Solar stands out from these competitors as it offers complete turnkey solutions as well as the production of the Fresnel collectors. As a result, the customers receive the complete solution, including engineering, procurement, production, installation and maintenance, from a single supplier.

Integrating solar collectors into industrial processes requires customised engineering and system control mechanisms, for which in-depth technical understanding and experience is necessary.

Beside the small but growing number of direct competitors, the factor with the greatest influence on competition is the fossil fuel energy price that trade customers have to pay.

○ Business Description

Industrial Solar is a German engineering company with expertise within solar heating systems. The Company offers full service solutions to industry customers that have a vast demand for heat generation in their production processes. Industrial Solar offers services and products for each step of the process when a customer wants to convert to solar heating or integrate solar heating into its existing energy systems.

Industrial Solar begins by analysing the customer's situation regarding the current energy demand, existing system, location, the venue etc. and from this presents an engineering report. The engineering reports include a solution to the customer's request, as well as indications on cost, carbon emission savings and the customers return on investment. The engineering report constitutes the basis for further decisions and actions of the customer.

Having received the order the Company then does a detailed engineering and begins with the procurement of the needed components, material and work force, such as welders, in the customer's local area. The Company then, together with the hired work force, assembles and installs the system at the customer site. When the system is up and running, either individually or integrated into the customer's old energy system, the Company services the system when needed.

Hence, Industrial Solar is a "one-stop-shop" that offers turnkey solutions to customers. The Company takes full responsibility of the project from the initial analysis to functioning system and after services.

Vision and Mission

Industrial Solar's vision is to achieve a 100 percent renewable energy supply for industry. To contribute to this vision, the Company's mission is to design, engineer, procure, construct and maintain the most suitable renewable energy solutions onsite at industrial facilities.

Product and Technology

A Fresnel solar collector for industrial rooftops: LF-11

As solar thermal energy is expected to cover a substantial proportion of industrial heat demand in the future, Industrial Solar has developed a solution explicitly to address this significant demand – the LF-11 Fresnel collector. It is a linear concentrating solar collector in which tracked mirror rows follow the sun and direct the irradiation onto a central absorber tube, through which the heat carrier circulates.

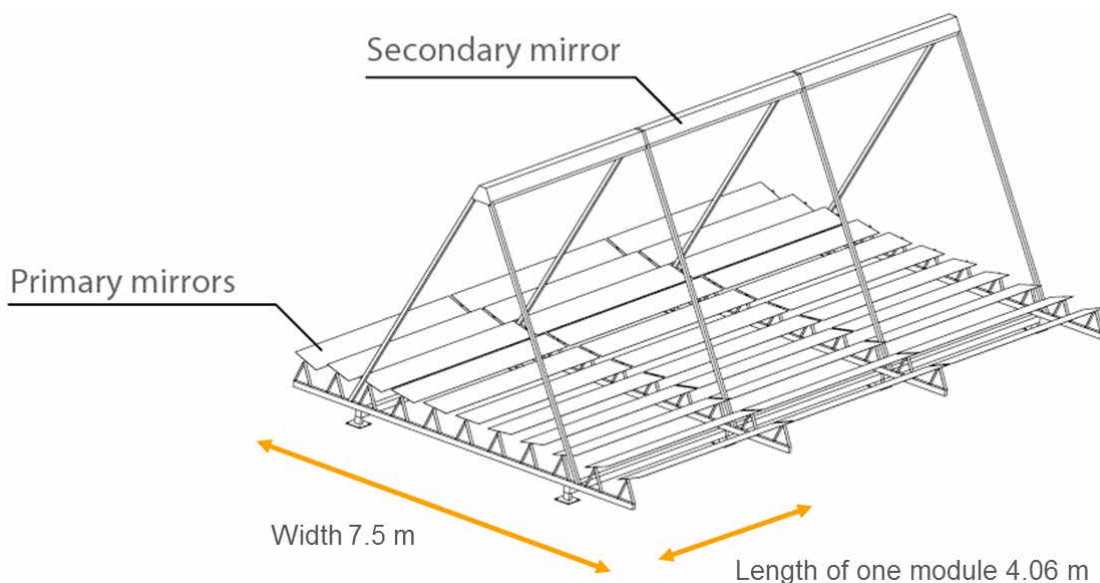

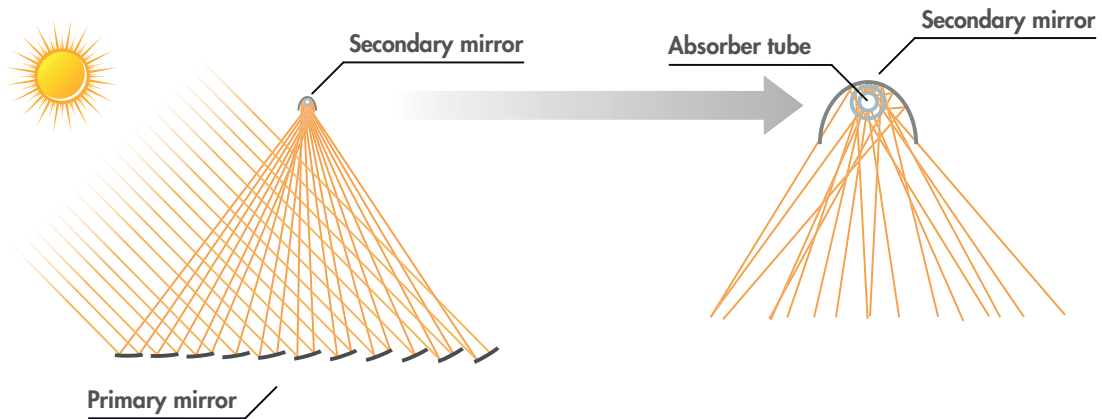

As the technology was designed for industry from beginning, it is today the most widely used Fresnel collector in industrial applications and the only one proven to be effective in the long term for commercial direct steam generation.

The collector uses tried and tested components from the concentrating solar power (CSP) industry, such as the highly reflective mirrors and the thermally efficient evacuated absorber tubes. Additionally, a well-designed steel structure combined with high-quality sensors and drives is used for optimised automatic controls that permit the system to operate

independently and protect themselves in the event of weather changes. This ensures that the system operates safely and with very little human intervention, extracting the maximum yield from the solar resource and guaranteeing high performance. Some components are produced in Europe and shipped to the construction site while others can be supplied locally, depending on the availability on the local market. Parts of the collector are pre-assembled for transportation whereas other parts are set up onsite, such as the mirrors and structure.



The collector appears to have a rather simple design, but consists of many components which have to be calibrated to each other for a functioning system, and has to resist temperature differences of up to 400°C. Industrial Solar has extensive experience in designing Fresnel collectors consisting of many steel components, highly reflective mirrors, vacuum absorber tubes in which the heat transfer fluid circulates, and a secondary reflector. The secondary reflector is used to redirect the solar radiation which does not hit the absorber tube directly in order to increase the performance, and also serves to protect the high-tech vacuum absorber tube against dust and hail. It consists of an aluminium housing and reflector. The mirrors have to follow the sun very precisely, for which intelligent software is required. The interconnections of all system components have complex but smart control software and hardware for safe and independent operation.

Technical Specification

The demand for process heat over 120°C cannot be met by non-concentrating solar collectors. Industrial Solar's LF-11 collector can generate temperatures up to 400°C in the power range from 500 kW to 20 MW at pressures of up to 120 bar.

Features of the LF-11 solar collector:

- Lightweight structure allows for rooftop installation.
- The design provides high ground space efficiency.
- Its vacuum receiver minimises heat losses.
- The modular design can be adapted to site constraints.
- Its controls allow precise setpoint selection.
- Its absorber can use all heat carriers.

Turnkey solutions

Customer problems

As it is ultimately imperative to achieve net zero emissions in order to stabilise the level of greenhouse gases in the atmosphere, one of the biggest worries today is industrial heating. Industry is responsible for one third of the total global primary energy demand⁷; 75% of industrial energy demand is accounted for by thermal energy use and only 25% by electricity use.⁸

Industry is dependent on the import of fossil fuels, which are

highly subsidised in many countries⁹, to generate heat for its processes. Industrial heating is also a major emitter of CO₂ beside other pollutants with adverse effects on human health and the environment. Controversially enough, such subsidies for fossil fuels are ten times higher than subsidies for renewable energy¹⁰. They are expected to decrease in future, with the effect of increasing energy costs.

In recent years, fossil energy prices have increased and the demand for energy from large developing economies will contribute to further increases in global energy prices. While fossil fuel reserves are steadily declining, industrial production is expected to grow by a factor of four by 2050¹¹.

Energy prices will become an even more important cost factor in industrial production in the future and companies need renewable energy in order to reduce their energy costs and carbon footprint. At the same time, they have to focus on their core business to remain competitive, and should therefore seek not only renewable energy products but also turnkey solution providers.

Industrial Solar's turnkey solution

As a result of the problems identified above, Industrial Solar transformed from a product manufacturer to a turnkey solution provider that offers a full-service package mainly based on its Fresnel collector technology as well as on other solar technologies. This turnkey solution service enables the customer to focus on their core business while Industrial Solar takes responsibility for engineering, procurement and construction (EPC) of the complete system and on request also the operation and maintenance

Turnkey solution process

In order to integrate solar heat into industrial processes, not only collectors are needed. Smart integration into existing systems is also essential. The interaction between the solar heating and fossil fuel-fired heat system has to be ensured via a customised control system which therefore is a key part of the system. Most collector manufacturers do not have the necessary experience or avoid the complex customisation of this type of control system. Industrial Solar possesses the necessary know-how and experience in designing, engineering and implementing such components and control systems to ensure the efficient and safe integration of solar process heat into existing systems.

7: IEA International Energy Agency (2016) "Key World Energy Trends. Excerpt from: World energy balances"

8: Solar Payback / IEA SHC Task 49

9: IEA International Energy Agency

10: NRDC, 2012 fossil fuel subsidy data, Oil Change International, renewable energy data, International Energy Agency

11: UNIDO (2011) "Renewable Energy in Industrial Applications. An assessment of the 2050 potential"

The graphic below shows a simplified turnkey solution consisting of a collector field and the interconnection components such as storage unit, pump and heat exchanger. These components together are described in the industry as the balance of plant (BoP) and form the link between the collector field and the industrial process.

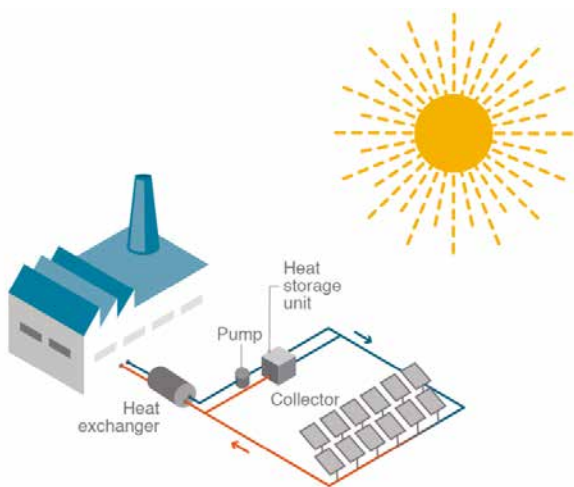

Source: SolarPayback

As a result, Industrial Solar is a one-stop shop with its own technologies enabling customers to purchase turnkey solutions for the generation of solar process heat for any kind of industry and application. The product portfolio includes the company's own LF-11 collector (described above), while other collector types and balance of plant components or peripheral components are purchased from partners and selected suppliers to be engineered, delivered and assembled for a turnkey solution. Beside the collector modules, typical balance of plant components are pressurisation systems, pumps, sensors, storage, heat exchange units and control hardware and software.

The graphic below shows a turnkey solution with a roof-mounted Fresnel collector (1) generating heat transferred via a storage system (3) for an industrial process (5) and to power an absorption chiller (4) for air-conditioning the building or for process cooling power (6). As a backup, a conventional fossil-fuel-fired boiler (2) is installed for periods without sunshine or night-shift operations. Depending on the available roof area and customer requirements, flat-plate collectors for low-temperature heat or PV modules for electricity generation (7) can be installed. The control system can deliver relevant data for monitoring (8) the system.



Source: Industrial Solar

Business Model

As described above, Industrial Solar delivers turnkey solutions mainly based on its innovative Fresnel collector technology as well as on other renewable energy products. Such systems typically consist of the collector field, pressurisation systems, pumps, sensors, storage, heat exchange unit and control hardware and software. When it receives a turnkey order, Industrial Solar engineers the complete system considering all relevant circumstances such as energy demand periods, process heat temperature, connection to existing energy system, roof load and ground usage criteria, etc. After the engineering for all components and their interconnections is finalised and approved by the customer, Industrial Solar starts the purchasing process. During the delivery period, the production site is prepared for a smooth installation. The installation itself is supervised by Industrial Solar cooperating with local service providers for welding and other technical work. In projects with Fresnel collectors, the collectors are produced by Industrial Solar onsite, whereas other collector types or system components are purchased from partners or local or international suppliers.

The Company presents a report for the Customer after the initial analysis and engineering that includes a cost saving analysis, carbon reduction analysis and return on investment analysis. The report also includes the costs for completing the project including sourcing, assembly, installation and further engineering. The customer pays a fee to industrial solar for the initial analysis and engineering report. After the customer accepts the contract based on the report, Industrial Solar receives a prepayment of around 40 percent of the total contracted amount. After that the Company receives milestone payments that differs depending on the project, but often looks as follows: 20 percent of the contracted amount is paid by the customer when it receives the components for the project, 20 percent at the start of assembly and installation at the customer site, 10 percent when the solar collector field is installed, and 10 percent at commissioning, i.e. when the system starts generating heat. However, the payment strategy is adjusted to each specific project since the projects often differ from each other.

Depending on system size and design, customers can save up to 80 percent on energy costs and simultaneously reduce carbon emissions. In addition, dependency on fossil fuels can be reduced and greater sustainability will be achieved. Overall, Industrial Solar solutions lead to higher competitiveness through lower energy costs and greater environmental sustainability to fulfil customer requirements today and in the future. These cost, carbon savings, and a return on investment analysis are presented to the customer in the report from the initial

Sales and marketing

Industrial Solar reaches its market and customers through different channels. The main methods are direct sales to end customers and via local partnerships in numerous countries. In addition, the company has a network of various boiler manufacturers and multinational companies such as GASCO (Australia), Dürr (Germany) and Park Energy (Mexico), who deliver products or systems which Industrial Solar's technologies or business model complement. The new Industrial Solar plans to renew pre-existing ties of this nature and forge new ones with similar of partners.

Customers and partners are identified either through an internal market research process or during conferences and exhibitions in which Industrial Solar participates.

Part of Industrial Solar's sales strategy is to sign cooperation agreements with companies which are present in our target markets, with a strong link either to the Company's technology or target customers. Such agreements are not based on exclusivity for certain countries, region or industries. However, Industrial Solar accepts project or customer exclusivity for a certain period. Typically the company joins forces with the partners to develop the market and specific projects. The partner will receive a commission fee in the case where Industrial Solar receives an order. Depending on the size of the project and margin of the order the commission ranges between 3-10% of the collect turnover. Hence, turnover from engineering and periphery components is not part of the commission.

These agreements are not considered essential as they are non-exclusive. Industrial Solar can still sign other agreements with other partners acting in the same country/region, but with a different expertise or customer focus and network. As a result Industrial Solar is able to cooperate with several partners in the same region. This sales strategy, historically, have increased the number of developed projects and is expected to continue doing so in the future.

Industrial Solar is also mentioned in many scientific papers and press releases from customers about specific projects which it has implemented. The company also reports news on its website and has its own press release channels. In the past, several articles have been published in different magazines in order to inform different industries about Industrial Solar's technologies, solutions and projects. The company is also present on the main social networks.

Research and Development

Industrial Solar has previously been involved in many internal and publicly funded R&D projects. The Company's own collector LF-11 is continuously being improved, mainly to achieve lower production costs by using cheaper components

and ensuring a shorter installation time. This R&D work ensures that the company has in-house knowledge and experience enabling it to improve its solutions with regard to new technological developments.

Presently, the company is carrying out R&D projects to optimise the solar collectors for roof installations, conducting research regarding improvements in system design, and developing automatic robot cleaning for the mirrors. These projects are part of Industrial Solar’s overall strategy to further optimise the collector design and system integration in order to reduce costs.

Organisation

Industrial Solar Holding Europe AB is managed by Christian Zahler as CEO.

Industrial Solar’s operations are headquartered in Freiburg (Germany) at Industrial Solar GmbH, a 100 percent subsidiary of the Swedish holding company. The managing directors of the subsidiary are Christian Zahler (CEO) and Tobias Schwind (CFO).

The company has a strong culture of staff development, including continued professional development, which is actively encouraged. Industrial Solar cooperates with students and scientists from national and international universities and research institutes, employing students to work alongside their studies. During the business year 2017 the company had 17 employees, with a mixture of full-time and part-time contracts. On average the full-time equivalent in this year has been 8.4 and 10.2 employees including students. Currently the company head count is 14 respective 8.6 full time equivalent people.

Current and future reports, press releases and other market communication from the Company will mainly be published in English, unless regulations and laws requires that a Swedish translation is published, in which cases the Company will publish in both languages.

The organisational structure is as follows:

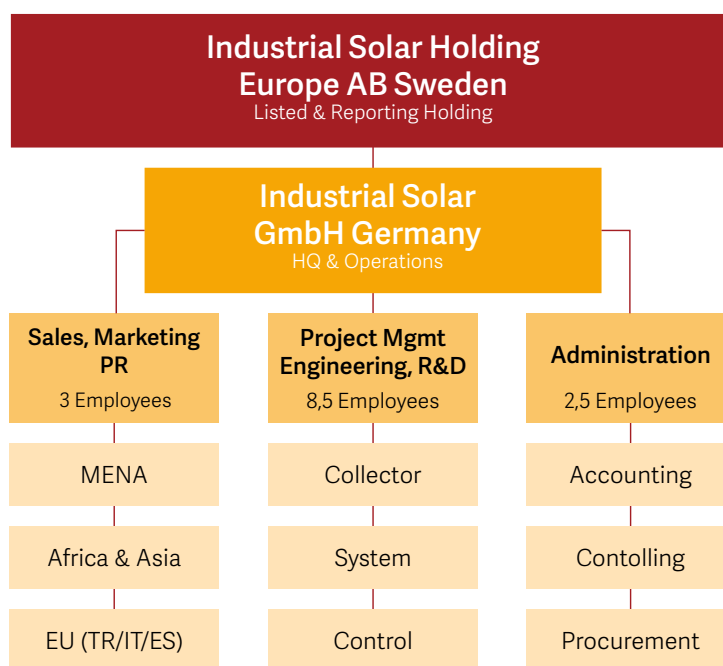

○ Company History and Sample Projects

History

Foundation and technology

Long before Industrial Solar was founded in 2008, researchers at the Fraunhofer Institute for Solar Energy Systems, the largest solar research institute in Europe, were already working on the Fresnel collector concept for large-scale solar thermal power plants. The founders of Industrial Solar quickly understood that this Fresnel technology would be perfectly suited to cover industrial process heat demand and developed a collector technology for industrial applications.

2008-2013: product manufacturing

Industrial Solar implemented one of its first projects in 2008 in Seville, Spain, where the Spanish utility gasnatural aimed to reduce the high energy demand for cooling the university building during the summer period. The Fresnel collector field which was delivered was used to power a thermally driven chiller. A winery in Tunisia also used this technology to power an absorption chiller. The Company delivered further Fresnel collectors to the Middle East for Masdar, Abu Dhabi (2009), the ES Group's solar showcase stadium Doha, Qatar (2010) and Qatar Science and Technology Park (2013). During this period, the collector was optimised and projects were realised in the automotive sector (2012 Dürr, Germany; Fischer, Germany).

2014 onwards: turnkey solution provider

From 2014 on, Industrial Solar transformed from a product manufacturer to a solution provider, and today's product portfolio also includes other technologies besides the Fresnel collector to account for the diverse energy needs in different industries. In 2014 the company delivered a solar cooling system for the largest telecommunication provider in Africa (MTN, South Africa). In 2016 the pharma company Pfizer, Germany, implemented its second project with Industrial Solar as the turnkey solution provider for heating air. Another solar steam generation system was commissioned in 2017 for Japan Tobacco International (JTI) in Jordan.

Until 2013, Industrial Solar only delivered the collector field shown in the simplified graphic above. From 2014 on it began to offer and deliver these turnkey solutions, mainly for Fresnel technology but also for other collector technologies where appropriate. Fresnel collectors, parabolic trough collectors or various types of non-concentrating collectors can be used depending on the specific requirements with regard to temperature, pressure, heat transfer fluid (water, oil, steam, air), roof load, and location.

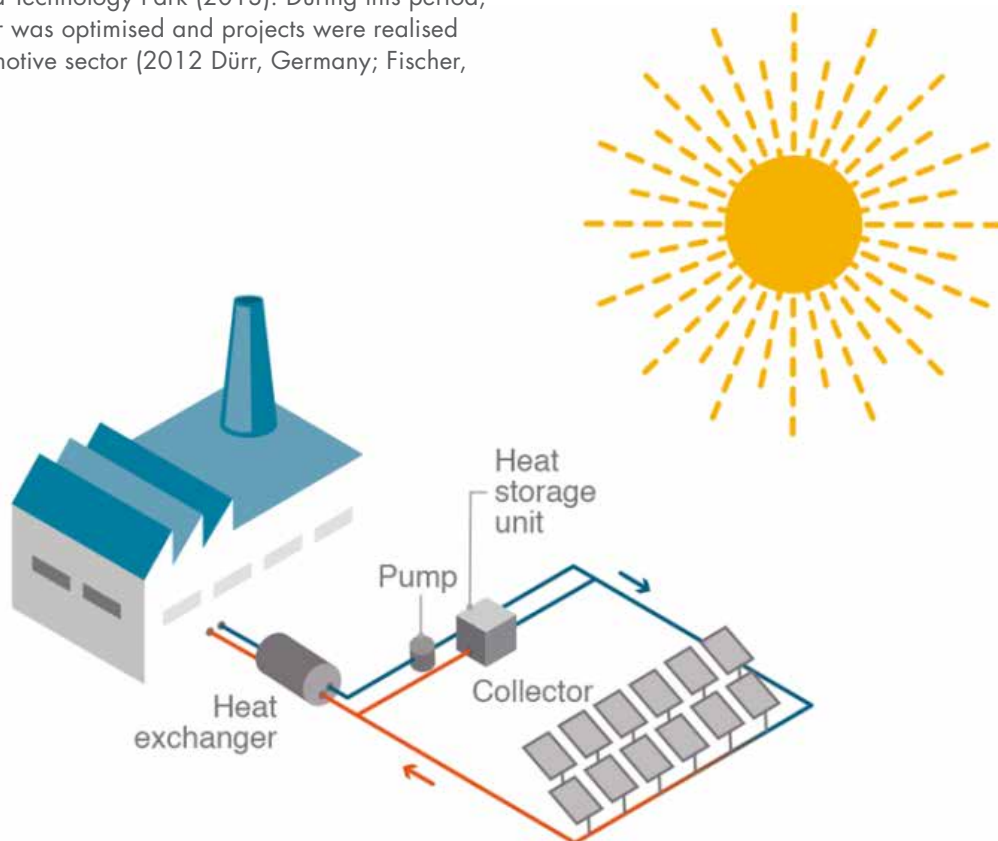

Source: SolarPayback

Sample Projects

2014 Lighthouse project MTN South Africa

MTN is the largest telecommunication company in Africa. A major share of its energy consumption is needed for cooling the data centre. In 2014 MTN decided to cut power consumption by installing a Fresnel collector from Industrial

Solar to run an absorption chiller. Cooling capacity: 330 kW, annual yield: 390 MWhth, CO₂ emissions savings: 200 tons per year.



2017: Lighthouse project Japan Tobacco International (JTI) Jordan

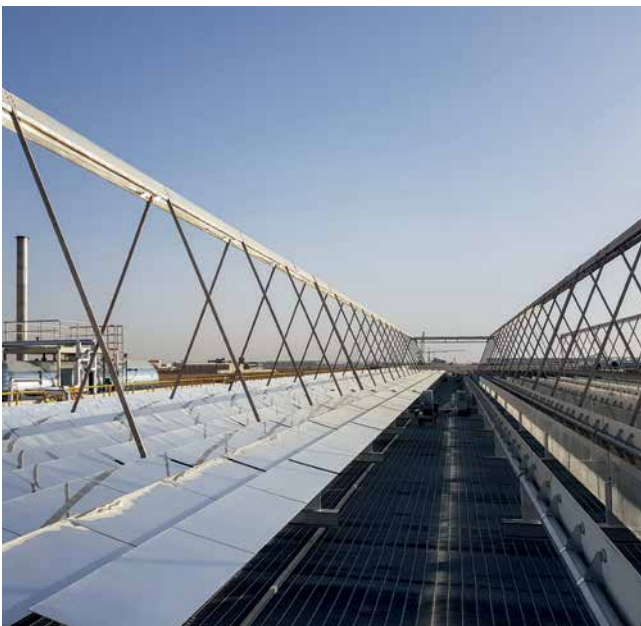

In 2017, JTI's Jordan facility became the first tobacco factory in the world to use solar steam generation. A Fresnel collector field from Industrial Solar is installed on the roof of the facility and provides sustainable steam for the process heat demand as well as for a thermally driven chiller. This allowed JTI to drastically cut both carbon emissions and fuel costs. Capacity: 700 kW, annual yield: 1,350 MWhth, CO₂ emissions savings: 500 tons per year.

So far more than a dozen projects have been implemented in eight countries, in which the Company delivered turnkey solutions in some of them.

○ Board of Directors, senior executives and auditor

Industrial Solar's Articles of Association stipulate that the Board of Directors is to consist of a minimum of three and a maximum of ten members, with a maximum of ten deputy members. Industrial Solar's Board of Directors currently comprises five members, including the chairman of the board.

Board of Directors



CHRISTIAN ZAHLER
CEO/ Board Member / Managing Director of Germany-based operational subsidiary (since 2008)

After having studied physics for two years at the University of Ulm, Christian Zahler decided to focus on solar energy by moving to Freiburg to join the Fraunhofer Institute for Solar Energy Systems ISE and finish his physics studies at the University of Freiburg. In 1995 he completed his Diplom thesis at Fraunhofer ISE, in the Department for Thermal and Optical Systems (TOS). The title was "Thermal optimisation of a solar-powered, flat-piston Stirling cycle engine".

In the following years he won grants from the DAAD, the EU's Marie Skłodowska-Curie Actions program and Norsk Hydro, and worked on European standards for solar thermal systems at a national research institute in Lisbon as well as on a comparison of different types of solar façades at NTNU and SINTEF in Trondheim, Norway.

In 1999 he returned to Freiburg and joined the Fraunhofer ISE spin-off PSE GmbH, where he became Head of Department for Solar Thermal Systems, responsible for the development of the Fresnel process heat collector and a team of 15 people. He was also responsible for public relations and marketing.

In 2008, together with Tobias Schwind and Andreas Häberle, he founded a new company today named Industrial Solar GmbH, which took over the Fresnel collector technology for industrial process heat applications from PSE.

Christian is a physicist and solar energy expert with 25 years of national and international experience in R&D, project management, consulting, sales, marketing and public relations. He has a versatile, innovative and self-motivated mind with first-class analytical, design and problem solving skills. He also possesses proven leadership skills involving managing, developing and motivating teams to achieve their objectives.

Holdings in the Company

Christian Zahler owns 1,244,859 shares in Industrial Solar, corresponding to approximately 24.5 percent of the company.

Compulsory liquidation and bankruptcy

Within the last five years, Christian Zahler has been involved in the insolvency proceedings of Industrial Solar GmbH, which was then restarted with Absolicon as the new strategic investor.

Industrial Solar signed a convertible loan with a strategic Chinese investor in 2015. The loan agreement contained the option to become a majority shareholder through conversion of the loan combined with an additional investment. At the time the loan was due and the option expired, the investor from China was not able to further invest as his core business was in a critical situation. Nevertheless, Industrial Solar was able to find a

new potential strategic investor. Unfortunately, at the end of April 2018, a conflict of interest between these two investors based on competing business units could unexpectedly not be resolved and Industrial Solar GmbH had to file for insolvency in early May 2018. Absolicon Solar Collectors AB recognised this opportunity and became the new strategic investor. A shell company was bought by Absolicon and named Industrial Solar Holding Europe AB. The holding company itself bought a German shell GmbH

and holds 100 percent of the shares. This GmbH signed an asset deal with the administrator, taking on the complete staff of the old company as well as the name rights, so that the new company could continue to operate as Industrial Solar GmbH. Industrial Solar Holding Europa AB was then able to initiate business activities in early August 2018.

Engagements and ownership during the last five years

Company	Position	From (year)	To (year)	Ownership>10%
Industrial Solar Holding Europe AB	CEO / Board Member	2018		Privately 24.5%
Industrial Solar GmbH, 100% owned by Industrial Solar Holding Europe AB	Managing Director	2018		
Carbon Free Industry UG	Board Member	2018		Privately 33.33%
Industrial Solar GmbH*	Managing Director	2008	2018	Privately 12.25%

*Bankruptcy declared in May 2018



JOAKIM BYSTRÖM
Chairman of the Board (2018)

Joakim Byström grew up in the family business Logosol and has started several companies. Byström has extensive specialist competence within solar thermal networks. Joakim is also on the board of Logosol AB.

As chairman of Unga Forskare, the Swedish association for young researchers, he took part in the UN's environmental negotiations and began to develop concentrating solar collectors.

Holdings in the Company

Joakim Byström owns 798,391 shares in Industrial Solar, corresponding to approximately 15.70 percent.

Compulsory liquidation and bankruptcy

Joakim Byström has been involved in a company entering into bankruptcy, compulsory liquidation or administration within the last five years.

Engagements and ownership during the last five years

Company	Position	From (year)	To (year)	Ownership>10%
Priono AB	Chairman	2007		20% privately
Logosol AB	Board Member	2010		20% through Priono AB
Eniara AB	Board Member, CEO	2010		100% privately
Technichus i Mitt Sverige AB	Board Member	2014	2016	
Absolicon Solar Concentrator AB*	Chairman, CEO	2007	2013	
Absolicon Solar Collector AB	Board Member, CEO	2013		38,5%
Blixfokus Kommunikationsbyrå AB	Board Member	2014		25% privately
Byggnadsföreningen Riddaren u.p.a.	Board Member	2005		

*Bankruptcy concluded 2013



TOBIAS SCHWIND
Board Member / Managing Director of Germany-based operational subsidiary (since 2008)

Tobias studied economics in Germany and holds an MBA from ESCP-Europe, France.

He was previously an investment manager at Fraunhofer Venture, responsible for multiple start-ups in the field of renewable energy technologies. Additionally, he has several years of experience in building up new production sites and in international business development from foundation to IPO. From 2006 to 2009 Tobias was a board member at Bio-Gate AG, a German stock-listed company.

Holdings in the company

Tobias Schwind owns 1,244,858 shares in Industrial Solar, corresponding to approximately 24.5 percent of the company.

Compulsory liquidation and bankruptcy

Within the last five years, Tobias Schwind has been involved in the insolvency proceedings of Industrial Solar GmbH, which was restarted with Absolicon as the new strategic investor. See full description of the circumstances under "Christian Zahler" above.

Engagements and ownership during the last five years

Company	Position	From (year)	To (year)	Ownership>10%
Industrial Solar Holding Europe AB	CEO / Board Member	2018		Privately 24.5%
Industrial Solar GmbH, 100% owned by Industrial Solar Holding Europe AB	Managing Director	2018		
Carbon Free Industry UG	Board Member	2018		Privately 33.33%
Industrial Solar GmbH*	Managing Director	2008	2018	Privately 12.25%

*Bankruptcy declared in May 2018



OLLE OLSSON
Board Member (since 2018)

Olle is a civil engineer with a degree in engineering physics from Uppsala University and has worked as a research engineer in the field of solar energy for almost ten years.

In addition to a broad market overview and both theoretical and practical knowledge of oil energy installations, Olle also has experience in management and corporate finance.

Holdings in the company

Olle Olsson has no shareholdings in the Company.

Compulsory liquidation and bankruptcy

Olle Olsson has been involved in a company entering into bankruptcy, compulsory liquidation or administration within the last five years.

Engagements and ownership during the last five years

Company	Position	From (year)	To (year)	Ownership>10%
Absolicon Solar Concentrator AB*	Deputy	2008	2013	20% privately
Absolicon Solar Collector AB	Chairman	2014		
Mxsol AB	Board Member	2015		100% privately

*Bankruptcy concluded 2013



JÜRGEN PETERSEIM
Board Member, independent (since 2018)

Dr Jürgen Peterseim is half German and half Australian and is Eckrohrkessel’s (ERK) executive director for strategy and new products. After finishing his industrial engineering degree in 2003 in Germany, he joined ERK as a project manager for industrial-scale renewable and energy efficiency projects.

From 2007 to 2015 he lived in Australia and worked on concentrated solar power and energy efficiency projects. Between 2011 and 2014 he did his PhD on concentrated solar power hybrid plants at the University of Technology, Sydney, where he is still an Honorary Associate. Since his return to Germany in 2015 he has focused on transferring existing thermal engineering expertise to new products and markets to shorten product implementation times and reduce technology risks.

Holdings in the company

Jürgen Peterseim has no shareholdings in the Company.

Compulsory liquidation and bankruptcy

Jürgen Peterseim has not been involved in a company entering into bankruptcy, compulsory liquidation or administration within the last five years.

Engagements and ownership during the last five years

Company	Position	From (year)	To (year)	Ownership>10%
ERK Eckrohrkessel GmbH, Berlin, Germany	Executive Director	2018	Present	
ERK Eckrohrkessel GmbH, Berlin, Germany	Director – Strategy & New Products	2015	2017	

Senior executives

Christian Zahler, CEO of Industrial Solar Holding Europe AB as well as Board Member and Managing Director of Industrial Solar GmbH.

Tobias Schwind, Board Member of Industrial Solar Holding Europe AB and Managing Director of Industrial Solar GmbH. For personal descriptions, see the section 'Board' above.

Auditor

The Company's auditor is KPMG, Nya Hamngatan 12, 2 tr, 851 06, Sundsvall, Sweden. Lars Skoglund, State-Authorised Public Accountant, has been the auditor in charge since the restart. The auditor for the previous annual reports was bws Graf Kanitz in Freiburg, Germany.

Remuneration of Board and senior executives

The remuneration paid to the Chairman and members of the Board is decided by the Annual General Meeting. For the 2018 fiscal year, each Board member receives EUR 750 per physical board meeting plus travel expenses.

CEO Christian Zahler currently receives a salary of EUR 80,000 p. a. from Industrial Solar GmbH. There are no result-based bonuses in Zahler's agreement and no compensation for his role as CEO of Industrial Solar Holding Europe AB.

The managing director Tobias Schwind currently has a salary of EUR 80,000 p. a.. There are no result-based bonuses in Schwind's agreement.

No amounts have been allocated for future pension commitments for the Company's employees. Pension benefits may, however, be paid out as part of an individual employment contract. There is no financial commitment to any Board member or other executive in the Company after the termination of employment.

Conflicts of interest and related-party transactions

Both Christian Zahler and Tobias Schwind are co-founders of and partners in Carbon Free Industry UG (CFI) and each own 33.33 percent of the company. CFI develops financing solutions for renewable energy projects mainly from Industrial Solar's project pipeline.

To avoid potential conflicts of interest, the Board of Industrial Solar has the power of veto in any kind of business contract with CFI. The power of veto enables the Board of Industrial Solar to control business with CFI and to refuse any contract or transaction in the event of any conflicts of interest related to Industrial Solar's business activity.

There are, as far as the Board is aware, no other potential conflicts of interest or related-party transactions between the Company and any Board member or senior executive.

Other information about Board members and senior executives

It is the board of director's intention to nominate a sixth board member to the annual meeting in 2019. The nominated board member will be of Swedish nationality and independent from the Company and its larger shareholders.

No Board member or senior executive has any familial or other relationship with any other Board member or senior executive. No Board member or senior executive has been involved in any bankruptcy or liquidation proceedings or bankruptcy management other than what is stated under the description of each person above. No Board member or senior executive has been involved in fraud-related legal proceedings in the last five years. None of the above senior executives or members of the Board have been prevented from acting as a member of any issuer's board or management team within the past five years.

○ Financial Overview

Historical financial information and applied reporting standards

The financial information, including both pro forma and actual numbers, have been prepared in accordance with the Swedish Accounting Standards Board's regulation BFAR 2012:1 for annual reports and consolidated accounts (K3). They have been approved by the company's auditor Lars Skoglund from KPMG/Sundsvall.

Asset acquisition

The asset acquisition consisted of all the assets of the old GmbH that went into bankruptcy. None of the liabilities were assumed. The consideration transferred amounted to 45 000 Euro and the analysis of the purchase is as follows,

Consideration transferred: - 45 000 EUR

Machinery purchased: + 19 000 EUR

Inventory and tools purchased: +26 000 EUR

Total: 0

In addition, all relations with clients and suppliers of the old company in combination with ongoing projects were transferred to the new company.

Pro forma introduction

The pro forma is presented for the sole purpose of informing of and highlighting facts. The pro forma presentation is by nature intended to describe a hypothetical situation and thus does not serve to show the company's actual financial position or results. Furthermore, pro forma accounts are not representative of how the business results will look in the future. Investors should be careful to put too much emphasis on pro forma statements. In the pro forma report, no synergies or integration costs have been taken into account. In addition, the pro forma statements include non-recurring costs directly related to the acquisition. This pro forma statement is presented for the sole purpose of being used in connection with the offer and the trading at Spotlight Stock Market as stated in this memorandum. The pro forma statement should be considered together with other information presented in this memorandum.

Pro forma assumptions

In the following is provided two pro forma statements. The pro forma are income statements for 2017 and for January to July 2018. The pro forma are based on the original financial figures of the old company and changed according to the assumptions in this text. The original financial figures were in EUR. For the purpose of this memorandum, they have been translated to SEK with average exchange rates (exchange rate data received from Riksbanken 2018-10-15). The intention with the pro forma is to reflect how the income statements of the old company would have been affected

if the bankruptcy and the following asset acquisition would have taken place at a different point in time. The assumption in the pro forma is that the bankruptcy and the asset acquisition occurred at the 1st of January 2017.

An important assumption in the pro forma is that the operations of the old company would have been unaffected by the bankruptcy and the asset acquisition. The motivation is that all the assets of the old company were included in the asset acquisition, and with it also came the relations with clients and suppliers as well as the ongoing projects. In practice, the asset acquisition meant that a business was purchased. Thus, there is no reason to believe that the asset acquisition would have had any effect on the EBIT of the old company.

However, with the bankruptcy, the old company's liabilities were cancelled, and no obligations for repayments of the old company's liabilities were assumed by the new company. Thus, the financing side of the old company would have changed given that the bankruptcy would have occurred at the date stated above. The old company was to a large extent indebted with a convertible loan that, with Swedish K3, would have led to very high financial expenses for all of the time periods covered by the two pro forma statements. With bankruptcy, this loan, together with all other loans, would have been cancelled. Thus, all financial expenses of the old company has been removed in the pro forma statements. Furthermore, in 2017, there were changes in the conditions of the convertible loan that led to a fair value gain and consequently a financial income of 100 000 Euro. In the pro forma, this financial income has also been cancelled.

After the asset acquisition, the new group, consisting of Industrial Solar Holding Europe AB and Industrial Solar GmbH, has taken up loans from Absolicon amounting to 0,8 M SEK. The annual interest rate on these loans is 1%. For the pro forma statements, the assumption is that the loans from Absolicon have been taken to their fair values. In the pro forma statements, the financial expenses relating to these loans have been added.

In addition, the loan from Absolicon is to be repaid in SEK. Since the reporting currency of the old GmbH was EUR, the loan would have led to translation differences. In both pro forma statements, there is an exchange gain added (exchange rate data received from Riksbanken 2018-10-15).

Furthermore, when Industrial Solar Holding Europe AB bought the German company, a service fee of 3500 Euro was included. In the financial statement for August 2018 included in this report, this service fee has been expensed immediately. The assumption in the pro forma is that this would have occurred also if the purchase of the German

company would have taken place at the 1st of January 2017. Thus, a financial expense of 3500 Euro has been added to the pro forma statement of 2017.

See below for the pro forma adjustments that have been made to the financial statements of the old GmbH. Financial information incorporated for reference is:

Income Statement

Proforma income statement per the 01-12/2017 (as if acquisition was made 1/1-2017)

This period indicates the operations of the complete business year 2017 before the conflict of interest between an old and potential new investor appeared in April 2018 which led to the insolvency. However, the financial net has been adjusted according to the assumption in the pro forma that the acquisition took place at the 1st of January 2017.

Proforma income statement per the 01-07/2018 (as if acquisition was made 1/1-2017)

This period shows the financials of the old company until it got bankrupted. The company was operated by the administrator from early May until end of July and searched mainly for financing and investors in this period. By August

2018, this search did no longer continue, and thus it has been decided to only construct the pro forma until July 2018 and instead include the actual figures of the new company per August 2018. Just as for the pro forma for 2017, the financial net has been adjusted according to the assumption in the pro forma.

The real numbers for the new company per the 08/2018

Absolicon's loan enabled the restart of the business from August 1st 2018 on via a new company which took over all assets from the old company for EUR 45k. The new company is now in the process of transferring projects from the old company.

Balance Sheet

Balance sheet of the new company per the 08/2018

Income statement

Consolidated income Consolidated income

	Note	2018-08-01- 2018-08-31	2018-01-01- 2018-07-31	2017-01-01- 2017-12-31
		SEK	SEK	SEK
			Pro forma	Pro forma
Net sales		–	881 506	15 379 923
Change in inventories of products in progress, finished goods and work in progress		–	-1 570 130	-142 199
Work performed by the Company for its own use and capitalised		–	–	666 246
Other operating income		–	20 671	267 156
		–	-667 953	16 171 126
Operating expenses				
Raw materials and consumables			-292 283	-8 138 650
Purchased services			-12 110	
Other external costs		-144 637	-2 765 415	-2 684 127
Employee benefit expenses		-412 659	-3 316 231	-5 515 601
Depreciation, amortisation and impairment of property, plant and equipment and intangible assets		-7 834	-225 389	-301 713
Operating profit/loss		-565 130	-7 279 382	-468 965
Profit/loss from financial items				
Translation differences		22 624	76 616	54 452
Interest expense and similar profit/loss items		-37 315	-4 661	-41 655
Profit/loss after financial items		-579 821	-7 207 427	-456 169
Profit/loss before tax		-579 821	-7 207 427	-456 169
Tax on profit for the year		–	42	–
Net profit/loss for the year		-579 821	-7 207 385	-456 169

Balance sheet

Consolidated balance sheet

	Note	2018-08-31
		SEK
ASSETS		
Non-current assets		
<i>Property, plant and equipment</i>		
Technical equipment and machinery		198 738
Other equipment and tools		271 958
		<u>470 696</u>
Total non-current assets		470 696
Current assets		
<i>Cash and bank balances</i>		
Cash and bank		1 262 102
Total current assets		<u>1 262 102</u>
TOTAL ASSETS		<u>1 732 799</u>

Consolidated balance sheet

	Note	2018-08-31
		SEK
EQUITY AND LIABILITIES		
<i>Equity</i>		
Share capital		500 000
Additional paid in capital		1 047 848
Reserves		-6 033
Other equity incl. net profit/loss for the year		-579 821
		<u>961 995</u>
<i>Provisions</i>		
<i>Non-current liabilities</i>		
Debt to related parties		770 804
		<u>770 804</u>
TOTAL EQUITY AND LIABILITIES		<u>1 732 799</u>

Statement of changes in equity

Consolidated statement of changes in equity

2018-08-31					
	<i>Share capital</i>	<i>Additional paid in capital</i>	<i>Reserves</i>	<i>Profit-/loss brought forward incl. net profit-/loss for the year</i>	<i>Total equity</i>
Opening balance	500 000			-	500 000
Net profit/loss for the year				-579 821	-579 821
<i>Changes in carrying amounts that are accounted for directly in equity</i>					
Translation difference			-6 033		-6 033
<i>Total</i>	-	-	-6 033	-	-6 033
<i>Transactions with owners</i>					
Shareholders' contribution		1 047 848			1 047 848
<i>Total</i>	-	1 047 848	-	-	1 047 848
At year end	500 000	-		461 995	961 995

Cash flow Statement

Consolidated cash flow statement

	08/2018
	SEK
Operating activities	
Profit/loss after financial items	-579 821
Adjustments for non-cash items, etc.	-14 146
Cash flow from operating activities	<u>-593 967</u>
Investing activities	
Acquisition of property, plant and equipment	-470 030
Cash flow from investing activities	<u>-470 030</u>
Financing activities	
Received shareholders' contribution	1 047 848
Borrowings	768 663
Cash flow from financing activities	<u>1 816 511</u>
Change in cash and cash equivalents	752 514
Cash and cash equivalents at beginning of year	500 000
Translation difference on cash and cash equivalents	9 588
Cash and cash equivalents at end of year	<u>1 262 102</u>

Notes to the pro forma financial statements

Note Accounting principles

The Income Statement and Balance Sheet have been prepared in accordance with German GAAP for the numbers of 2017 as well as from January to July 2018 and restated for illustrative purpose to K3 and pro forma statements. The accounting principles for material items are according to K3. The numbers for August 2018 has been prepared in accordance with K3.

The Annual Report has been prepared in accordance with the Annual Accounts act and for the first year also according to the Swedish Accounting Standards Board's generally accepted accounting principles BFNAR 2012:1 Annual Report and consolidated accounts (K3).

Assets, provisions and liabilities have been valued at acquisition cost unless otherwise is stated below

Intangible assets

Other intangible assets

Other intangible assets acquired are accounted for at acquisition cost less accumulated amortisation and impairments.

Amortisations

The amortisation is made linearly over the asset's estimated useful life. The amortisation is recognised as an expense in the income statement.

Acquired intangible assets

Licences	Useful life	5 years
----------	-------------	---------

Property, plant and equipment

Property, plant and equipment are accounted for at acquisition cost less accumulated depreciations and impairments. The acquisition value includes, in addition to the purchase price, other expenditures directly attributable to the acquisition.

Indirect costs of production, which amount to more than an immaterial part of the total expenditure for the production and amount to more than an insignificant amount, are included in the acquisition value

Additional expenditures

Additional expenditures that fulfil the criteria of an asset are included in the carrying amount of the asset. Expenditures for ongoing maintenance and repairs are recognised as expenses when incurred.

For technical equipment, the difference in use of significant components have been assessed as essential. Therefore, these assets have been divided into components, which are depreciated separately.

Depreciations

Depreciations are done linearly over the asset's estimated useful life, since it reflects the expected usage of the asset's future economic benefits. The depreciation is recognised as an expense in the income statement.

Considerations have been taken into account regarding the estimated residual value, determined at the acquisition date in the then prevailing price level.

Technical equipment and machineries Other equipment and tools	Useful life	3-10 years 1-13 years
--	-------------	--------------------------

For technical equipment the difference in use of significant components have been assessed as material. The main divisions are mounting platform, mounting device, test stand for quality inspection demonstration collector incl. hardware and piping, extension collector under construction and mirror production plant. The useful lives of these components have been assessed to vary between 3-10 years

Impairments - Property, plant, equipment and intangible assets and shares in group companies

At every closing date, an assesment is made concerning whether or not there is an indication of if the asset's value is lower than the carrying value. If an indication exists, the recoverable amount of the asset is calculated. The recoverable amount is the highest of the fair value less cost to sell and the value in use. When calculating the value in use, future expected cash flows that the asset is expected to generate in the ongoing operations and when it is disposed are discounted to a present value. The discount rate used is before tax and reflects the marketable assessment the time value of money and the risks attributable to the asset. A previous impairment is only reversed if the reasons underlying the calculation of the recoverable amount at the last impairment have changed.

Leases

Lessee

All lease contracts are accounted for as operating lease contracts.

Inventory

The inventory is recognised at the lowest of the acquisition cost and net realisable value. Thereby risks of obsolescence have been considered. The acquisition cost is estimated according to the weighted average prices. The acquisition cost consists of, except expenditures for purchases, expenditures for bringing the goods to their current location and condition.

In self semi-manufactured and finished goods, the acquisition cost consists of direct costs of production and the indirect costs that amounts to more than an insignificant part of the total expenditures for the production. At the measurement, considerations have been taken into account regarding a normal capacity utilisation.

Financial assets and liabilities

Financial assets and liabilities are accounted for in accordance with chapter 11 (Financial instruments valued at acquisition cost) in K3. Convertible loans are divided into equity components and debt components in accordance with chapter 22 in K3.

Valuation of financial assets

Accounts receivable and other receivables that form current assets are valued individually at to the amount expected to be received.

Tax

Tax on profit for the year in the income statement consists of current tax and deferred tax. Current tax is the income tax for the current financial year, which refers to the year's taxable profit and the part of earlier financial years' income tax that have not been recognised. Deferred tax is the income tax for taxable profits referring to future financial years due to earlier transactions or happenings

Provisions

A provision is recognised in the balance sheet when the Company has a legal or informal obligation due to an occurred event and it is possible that an outflow of resources are required in order to settle the obligation and a reliable estimation of the amount can be made.

At the first reporting date, the provision is valued at the best estimation of the amount that will be required in order to settle the obligation at the balance sheet date. The provision is reviewed at every balance sheet date.

The provision is accounted for as the present value of future payments that are required to settle the obligation.

Revenues

The inflow of financial benefits that the Company receives or will receive on its own behalf are recognised as revenues. Revenues are valued at fair value of what has been received or will be received, less discounts.

Sale of goods

For sale of goods, the revenue is recognised at delivery.

For sale of goods, the revenue is recognised when the following criteria are fulfilled:

- The financial benefits associated with the transaction will probably flow to the Company,
- The revenue can be estimated reliably,
- The Company has transferred the material risks and benefits attributable to the goods ownership to the buyer,
- The Company does not any longer have an engagement in the ongoing administration that normally is associated with the ownership and does not exercise any real control over the sold goods, and
- The expenditures that have arisen or are expected to arise due to the transaction can be estimated reliably.

Service agreements and construction contract – fixed price

Revenues and expenditures from engagements at fixed prices are recognised as revenues when the performance is substantially completed (completion method).

Revenue is only recognised with the amount that corresponds to the incurred engagement expenditures that probably will be compensated by the orderer since the financial outcome cannot be estimated reliably.

Public grant

A public grant which is not associated with a demand on future performance is accounted for as a revenue when the terms for receiving the grant are fulfilled. A public grant which is combined with demands on future performance is recognised as a revenue when the performance is performed. If the grant has been received before the terms for recognising the grant as a revenue have been fulfilled, the grant is recognised as a liability.

Auditors report on the pro forma financial statements



The Auditor's Report on Pro Forma Financial Information

To the Board of Directors in Industrial Solar Holding Europe AB, 559110-3972

The Auditor's Report on Pro Forma Financial Information

We have audited the pro forma financial information in Industrial Solar Holding Europe AB's (Industrial Solar) prospectus named "Memorandum prepared by the Board of Directors of Industrial Solar Holding Europe AB in relation to the initial public offering and planned listing on Spotlight Stock Market".

The pro forma financial information has been prepared for illustrative purposes only to provide information about how the acquisition of Industrial Solar GmbH might have affected the consolidated balance sheet for Industrial Solar as of 2018-08-31 and the consolidated income statement for Industrial Solar for the year ended 2017-12-31 and the period ended 2018-07-31 and 2018-08-31.

The Board of Directors' responsibility

It is the Board of Directors' responsibility to prepare the pro forma financial information in accordance with the requirements of the Prospectus Regulation (EC) No 809/2004.

The auditor's responsibility

It is our responsibility to provide an opinion required by Annex II item 7 of Prospectus Regulation 809/2004/EC. We are not responsible for expressing any other opinion on the pro forma financial information or of any of its constituent elements. In particular, we do not accept any responsibility for any financial information used in the compilation of the pro forma financial information beyond that responsibility we have for auditor's reports regarding historical financial information issued in the past.

Work performed

We performed our work in accordance with FAR's Recommendation RevR 5 *Examination of Prospectuses*. This recommendation requires that we comply with FAR's ethical requirements and have planned and performed the audit to obtain reasonable assurance that the financial statements are free from material misstatements. The firm applies ISQC 1 (International Standard on Quality Control) and accordingly maintains a comprehensive system of quality control including documented policies and procedures regarding compliance with ethical requirements, professional standards and applicable legal and regulatory requirements.

We are independent of Industrial Solar in accordance with professional ethics for accountants in Sweden and have otherwise fulfilled our ethical responsibilities in accordance with these requirements.

Our work, which involved no independent examination of any of the underlying financial information, consisted primarily of comparing the unadjusted financial information with the historical information, assessing the evidence supporting the pro forma adjustments and discussing the pro forma financial information with the management of the company.

We planned and performed our work so as to obtain the information and explanations we considered necessary in order to obtain reasonable assurance that the pro forma financial information has been compiled on the basis stated on pages 35-44, and in accordance with the accounting principles applied by the company.

Opinion

In our opinion the pro forma financial information has been properly compiled on the basis stated on pages 35-44 and in accordance with the accounting principles applied by the company.

Sundsvall november 8th 2018

KPMG AB

Lars Skoglund

Authorized auditor/ auditor-in-charge

○ Comments on the financial overview

Background

Due to the described bankruptcy in May 2018, the Company's current activities are focusing on financing and restarting the business. The Company is working to transfer existing projects to the new company which started business operations in August 2018, and to receive new orders. The year 2018 should thus be considered an exceptional business year.

The new company took on all of the bankrupt company's assets from the administrator for EUR 45k. All debts and former losses remained with the bankrupt company. This enabled the new company to start with a completely new financing set-up and form a strategic partnership with Absolicon Solar Collector AB (read more about the partnership in the chapter "Legal matters and supplementary information").

Revenues and operating profit

Pro forma financial data until 31 July 2018 are referring to the bankrupt Industrial Solar GmbH as if the acquisition was made 1/1-2017 respective 1/1-2018. Financial data from August 2018 onwards are based on the newly incorporated Industrial Solar Holding Europe AB, whose relaunch was financed by Absolicon Solar Collectors AB. In 2018, the focus has been on financing and restarting the business and transferring all activities to the new company. Hence, the decrease in revenue in 2018 compared to 2017 is mainly caused by two factors: During the first 7 months of 2018 the old company searched for financing and investors. Second, during May-July 2018 the old company was operated by the insolvency administrator. Earnings per share are negative for all the periods provided in the financial overview.

Substantial tangible assets

The main tangible assets are the production equipment including tools for the primary mirror and some tools for the installation of the Fresnel collector. The IT infrastructure, consisting of workstations, notebooks and servers and office equipment, is also an important asset.

Substantial intangible assets

Industrial Solar possesses engineering expertise and know-how in designing Fresnel collectors and the associated turnkey solutions. This includes comprehensive control system knowledge for smart integration into existing process heat systems. The experience and know-how gathered during various R&D projects and projects for which Industrial Solar delivered turnkey solutions is unique and thus a substantial intangible asset.

Equity and liabilities

The Company currently has no collateral or contingent liabilities. The company has a conditional shareholders' contribution that will be repaid using disposable profit according to confirmed balance sheet provided that such repayment does not contravene good business practice, or, if the Company does not have any disposable profit, at liquidation after stake holders receive full repayment, but before shareholders.

Investments

Historically, the main investments have been associated with the development of Fresnel collector technology, such as in the successful implementation of a new primary mirror design in 2017. This development enabled lower component costs and a much higher production output while adding better reflectivity and easier onsite assembly and handling. This development includes the necessary assembly tools, which have been recognised as assets with a value of approx. EUR 100k.

Beside technology development, Industrial Solar has been involved in various national and international, partly publicly funded R&D projects. The projects have focused on technological system improvements, performance evaluation, collector development or feasibility studies.

Further investment activities to lower collector and system costs will take place with costs in the region of EUR 500-700k p.a., mostly personnel and materials/tools costs.

Ongoing concern

The existing working capital is not sufficient for the business during the next twelve-month period. However Industrial Solar has an agreement with Absolicon to receive further MSEK 1.2 as debt capital on request. In addition the company expects payments from taking over old and upcoming new projects of approx. MSEK 7.2 within the next 6 month which should deliver sufficient working capital for the next twelve month. It is the board of director's assessment that continuing operations exists.

Use of proceeds

The proceeds from the current issue, which is fully underwritten by existing shareholders, will amount to approximately SEK 16.6m after issue-related costs. It will, in full, be used for developing the business and products. More specifically, the company will use the proceeds to develop the Fresnel collector and the surrounding technology. The Fresnel collector development will focus on reduction of production costs and simplification of the installation process. The Company estimates that these developments will reduce the procurement costs by 30 percent. Accordingly, the Company estimates that the measures mentioned will

increase the margins in each project and at the same time decrease the time for the customers to achieve a positive return on investment.

The proceeds from the current issue will also be used to develop a prefabricated container that contains the peripheral components of the solar collector field. Peripheral components are the components that are not directly related to the solar collector, but needed in order to install the system at the customer site. Such components include pumps, pressurization system, valves, sensors and controls. A container of peripheral components will allow Industrial Solar to more efficiently integrate solar process heat systems into existing industrial energy systems. This will reduce the time of installation as well as the cost of installation and, in turn, enable Industrial Solar to deliver more projects as their capacity increase. The Company estimates that such container will reduce the time consumed installing the integration system by up to 50 percent.

The Company estimates that these projects will be finished and commercialized at the end of 2019.

Industrial Solar also intends to use a portion of the proceeds for international marketing and sales purposes. The Company will initially increase the international marketing budget, but believes that additional sales and marketing personnel are needed within the foreseeable future.

The proceeds will be used in the following order:

- 30% Further development of the Fresnel collector
- 35% Integration system (BoP) development
- 20% International sales and marketing
- 15% Project development

The Company has also established the following milestones in regard to the stipulated use of proceeds:

- Q3/2019 Development of new more effective drives is finished. The drives are estimated to be able to direct 50 percent more mirror area towards the sun. Improved drives will enable Industrial Solar to increase their margins and lower the price for their customers making them more competitive.

- Q3/2019 Development of a liquid mirror cleaning solution is finished. Such solution will enable the customers to have a cost efficient way of cleaning the mirrors from dust and other dirt. Industrial solar estimates that this will be an advantage compared to their competitors in their offering towards the customer.

- Q4/2019 Development of modularized and standardized container design for peripheral components is finished. The container will enable easy and quick connection between the solar field and the existing heat system at the site. Such container will increase the efficiency of installation, and thereby free up capacity for Industrial solar and lower the installation costs.

- Q1/2020 Development of new mechanical coupling that enables more efficient connection and alignment of mirrors. A new mechanical coupling will allow for shorter installation time, which in turn lowers the total cost for the project.

Significant changes after the last reporting period

Since 31 August 2018 Industrial Solar has been approved for listing at Spotlight Stock market.

Economic outlook

In view of the fact that Industrial Solar is still in an early stage of development, the Board has chosen not to provide any forecasts or other quantified predictions about the Company's future development.

Share information

The shares in Industrial Solar have been issued in accordance with Swedish legislation and are denominated in Swedish kronor

○ Share capital and ownership structure

(SEK). Under the current Articles of Association, only one share class – common shares – can be issued, with one vote per share. Prior to the rights issue, the share capital of Industrial Solar amounts to SEK 500,000, divided across 5,081,055 shares. All shares are fully paid. Industrial Solar's Articles of Association indicate that the share capital shall be at least SEK 500,000 and no more than SEK 2,000,000, and the number of shares shall amount to at least 5,000,000 and no more than 20,000,000 shares. The shares are freely transferable and fully paid.

Rights that accompany the Company's shares

Shareholders' rights regarding distribution of profits, voting rights, pre-emption rights for subscription of shares, etc. are governed partly by Industrial Solar Holding Europe AB's Articles of Association, which are available on Industrial Solar Holding Europe AB's website, and partly by the Swedish Companies Act.

Central stock register and ISIN number

The issued shares in Industrial Solar are registered in electronic form in accordance with the reconciliation provisions in the Articles of Association. Shareholders will not receive any physical share certificates. All transactions with the Company's shares are conducted electronically by banks and securities managers. New shares are registered in electronic format. There are thus no physical stock certificates. The share book is kept by Euroclear Sweden AB, whose address is Box 191, 101 23, Stockholm, Sweden. The shares' ISIN code is SE0011762517, the FISN code is INDUSTSOLA/SH and the CFI code is ESVUFR.

Dividend policy

The Company has not established a dividend policy. The payment of dividends is determined by the General Meeting

of shareholders. Any future dividends will be dependent upon several factors, such as future results, financial position and the Company's need for investment. Industrial Solar is currently in an expansion phase, meaning that specific predetermined expansion activities are prioritised. As a result, shareholders should not expect to receive any dividends in the coming years. In these circumstances, possible returns for the shareholders during the next few years will mainly depend on the evolution of the share price.

Dividends are payable to shareholders registered in the share register maintained by Euroclear Sweden as of the record date adopted by the shareholders' General Meeting. Dividends are normally distributed to shareholders through Euroclear Sweden as a cash payment, but may be paid out in another manner. If a shareholder cannot be reached, they will retain a claim to the dividend amount until the statute of limitations expires. At that time, the dividend shall pass to the Company.

Share warrants

The Company has not issued any warrants.

Convertible loans

The Company has not issued any convertible loans

Trading of the Company's shares

The Company's shares have been approved for trading on Spotlight Stock Market. The provisional date for the first day of trading is 15th of January 2019 and the stock will be traded under the short name ISHE.

About the marketplace

Spotlight Stock Market is the auxiliary trade name of ATS

Development of the share capital

Year	Event	Quota value	Change in share capital (SEK)	Total share capital (SEK)	Change in number of shares	Total number of shares	Issue price (SEK)
mar-18	Company registration	1	500 000	500 000	500 000	500 000	-
sep-18	Shares reduced to 1	500	-	500	-499 999	1	-
sep-18	Split	0,0984	-	500 000	5,081,054	5,081,055	-
dec-18	IPO*	0,0984	250 000	750 000	2,540,527	7,621,582	6.20
dec-18	Oversubscription*	0,0984	25 000	775 000	254,052	7,875,634	6.20

* if the rights issue is fully subscribed

** if the rights issue and oversubscription issue are fully subscribed

Finans AB, a securities company under the supervision of the Swedish Financial Supervisory Authority. Spotlight is an MTF platform. Companies listed on Spotlight have committed to follow Spotlight's listing agreement, which aims to ensure that shareholders and other actors on the market receive correct, immediate and consistent information on all circumstances which may affect the Company's share price.

Spotlight provides an efficient trading system accessible to banks and stockbrokers affiliated with Nasdaq Stockholm AB. This means that a party wishing to purchase or sell shares listed on Spotlight can do so through their normal bank or

stockbroker. The listing agreement and share prices can be found on Spotlight's website (www.Spotlight.se).

Ownership structure

As of the date of this Memorandum, the Company has approximately 3,200 shareholders. The below table describes the owner structure of Industrial Solar immediately prior to the Offering. The table also displays the owner structure after the Rights Issue and after the Oversubscription Issue, if they are fully subscribed.

Shareholder	Prior to the Offering		After the Offering		After the Offering and the Oversubscription Issue	
	Shareholdings		Shareholdings if the rights issue is fully subscribed		Shareholdings if the Rights Issue and Oversubscription Issue are fully subscribed	
	Shares	Percent	Shares	Percent	Shares	Percent
Christian Zahler	1 244 859	24,5%	1 244 859	16,3%	1 244 859	15,8%
Tobias Schwind	1 244 858	24,5%	1 244 858	16,3%	1 244 858	15,8%
Joakim Byström	798 391	15,7%	1 197 586	15,7%	1 197 586	15,2%
Other Shareholders*	1 792 947	35,3%	3 934 279	51,6%	4 188 331	53,2%
Total	5 081 055	100,0%	7 621 582	100,0%	7 875 634	100,0%

Authorisation

The Board of Directors resolved to implement the rights issue on the basis of an authorisation granted by the Extraordinary General Meeting on 26 September 2018. According to this authorisation, the Board may, on one or more occasions before the next Annual General Meeting, decide to increase the Company's share capital by no more than SEK 500,000 through a new issue of no more than 5,081,055 shares.

Such new share issues may be subject to a deviation from the shareholders' preferential rights and/or may involve an issue for non-cash consideration, debt swap or otherwise be subject to the terms of Chapter 13, Section 5, first paragraph, points 2 and 6, section 5, second paragraph, 1-3 and 5 of the Swedish Companies Act.

Issues pursuant to this authorisation shall be on market terms. The Board of Directors shall decide the terms and conditions for new shares under this authorisation as well as who shall be entitled to subscribe for the new shares. The reason for the Board's being able to decide on a new share issue deviating from shareholders' preferential rights and/or with a clause and set-off issue or otherwise subject to the abovementioned conditions is that the Company will be given scope for increasing the number of shareholders, strategic acquisitions of companies or operations.

The General Meeting also authorised the Board, or whomsoever the Board may appoint, to make minor adjustments to this decision that may be necessary in connection with registration with the Swedish Companies Registration Office and Euroclear Sweden AB.

Lock-up agreements

Christian Zahler, Tobias Schwind and Joakim Byström have all entered into agreements and undertaken not to, directly or indirectly, sell more than 10 percent of their respective shareholdings within a period of twelve (12) months from the first day of trading on Spotlight Stock Market. Exceptions from the obligation not to sell shares in the Company (lock-up) may be permitted under the terms of (and as an acceptance of) a public takeover offer. In all, 2,959,298 shares are covered by the lock-up, corresponding to approximately 37.6 percent of all shares after the offering, assuming full subscription of the offering and the oversubscription issue.

Liquidity provider

Industrial Solar will not employ a liquidity provider.

○ Legal matters and supplementary information

General information on Industrial Solar

Industrial Solar Holding Europe AB, with organisation number 559110-3972, was registered with the Swedish Companies Registration Office on 28 April 2017. The Company's LEI code is 549300HMLQ707POBTP63. The Company's association form is Aktiebolag (limited company) and is governed by the Swedish Companies Act "Aktiebolagslagen" (2005:551). The Company is public. The provisions of the Articles of Association do not have any implications above and beyond those of the Companies Act as regards changes in shareholders' rights. The shares in the Company are freely transferable. The registered office of the Board is in the municipality of Härnösand, Västernorrland County, Sweden.

The address of the registered office is:

Industrial Solar AB

Fiskaregatan 11

871 33 Härnösand

Sweden

Website: <https://www.industrial-solar.de/>

Company structure and shareholding

Industrial Solar holds 100 percent of the shares in the German operational subsidiary Industrial Solar GmbH.

Significant agreements

There are no agreements that substantially affect the prerequisites for the Company's to conduct the business activity in question.

Insurance

The Company has an insurance program that the Board considers appropriate for the Company's operations. The insurance coverage is subject to continuous review.

Disputes and legal relationships

The Company has not been a party to any legal proceedings or arbitration proceedings which have or have had significant effects on the Company's financial position or profitability at any time. The Board of Directors of the Company does not know of any circumstances that could lead to any such legal proceedings or arbitration proceedings.

Transactions establishing the group

In 2015 Industrial Solar signed a convertible loan with a strategic Chinese investor. The agreement included an option for the investor to become a majority shareholder by converting the loan and combining it with an additional investment. At the time the loan was due and the option expired, the investor was unable to further invest as his core business was struggling. However, Industrial Solar was able to find a new strategic investor. At the end of April 2018, a conflict of interest between

the two investors based on competing business units could not be resolved and Industrial Solar GmbH had to file for insolvency in early May 2018. This occurred since no additional investments could be made in Industrial Solar by strategic investors.

Absolicon Solar Collectors AB recognised this insolvency as an opportunity and became the new strategic investor. A shell company was bought by Absolicon and named Industrial Solar Holding Europe AB. The holding company itself bought a German shell GmbH and holds 100 percent of the shares in the German holding company. This GmbH signed an asset deal with the insolvency administrator, taking over all operations including staff and name rights. The new company could thus continue to operate as Industrial Solar GmbH. Industrial Solar Holding Europa AB started to take over the business activities in early August 2018.

Agreements

Co-operation agreements

Sunshine Engenharia

A co-operation agreement was entered into with Sunshine Engenharia on 9 August 2018. Under the agreement, Sunshine will engage in business development in Brazil as well as other countries in Latin America as the co-operation with the German subsidiary evolves. Sunshine will report regularly to the German subsidiary on all contacts and may be involved in local procurement and execution of a project as a subcontractor. The German subsidiary will in turn provide the technology and know-how which Sunshine will be able to use to market the solar technology, to create project proposals and will provide sector-specific information to address specific industries. The co-operation agreement contains an IP rights clause and a non-compete clause. The co-operation agreement does not contain any governing law clause. Each party shall bear its own costs and expenses with respect to the implementation of the agreement. A commission will be paid to Sunshine in the amount of 3-10 percent of the collector turnover. Parties will negotiate an appropriate commission structure depending on the uniqueness and viability of each project. The agreement expires after 24 months, if not prolonged upon mutual consent.

Other co-operation agreements

Previous co-operation agreements and agent agreements entered into by the insolvent Industrial Solar GmbH have not been updated for the German subsidiary. However, the old company's network and co-operations remain active. These agreements are general cooperation agreements stating that a more detailed and binding

agreement will be signed in connection with projects or a closer cooperation. The Company will make it a priority to update these agreements as soon as possible.

Customer agreements

The Company does not rely on any particular customers in terms of revenue. The business is built on different projects and therefore the customers vary and each customer is equally important. The typical customer is either a small or medium-sized enterprise, or a multinational company in the food, pharmaceutical, chemistry, or automotive industry. The Company does not apply any standard customer agreements. The customer agreements are mostly governed by Swiss or UK law.

Supply agreements

The Company does not rely on any particular suppliers. The suppliers provide specific components, such as mirrors, absorber tubes, drives, pumps, valves and steam drums. The Company does not apply any standard supply agreements. The supply agreements are often governed by German law.

Employment agreements

All employee agreements are in German and governed by German law. The Company or the German subsidiary has not adopted any guidelines for bonuses to employees as of the date of this Memorandum.

According to the German law on employee inventions, the employer is in principle entitled to own the rights to the invention. In return for the transfer of an invention, the employee has the right to equitable remuneration, unless they are expressly employed for inventing and paid accordingly. The amount of the remuneration is determined according to the German patent law and relates to the benefit that the company derives from the invention. This benefit can be determined using the methodology of licence analogy preferred by the German Supreme Court (OGH), by determining the internal benefit or by estimating it.

Agreements and transactions with Absolicon

Absolicon and Industrial Solar have a long track record in the solar process heat market and complement each other with different business models, specific expertise and regional strength. Absolicon has a strong presence in China and its key expertise is in upscaling collector production. Industrial Solar has a strong presence in the MENA region and its key expertise is in building turnkey solutions. While Absolicon and Industrial Solar complement each other in terms of both market access and competence, they will continue to operate independently in their respective focal areas.

Considering that both companies have the same end customers, complementary products and different business models, there are versatile synergies between them, such as:

- Sales of turnkey solutions including Fresnel LF-11 and Absolicon's PTC collectors
- Sales of Absolicon's production equipment
- Execution of R&D projects and application for R&D tenders
- Purchase cooperation
- Engineering for projects, systems, products and technologies
- General marketing
- Marketing to develop specific markets
- Financing of installations

Industrial Solar has also signed a cooperation agreement with Absolicon based on a sound commercial cooperation regarding R&D, marketing and sales. The co-operation agreement between the Company and Absolicon was entered into on 19 September 2018 and expires twelve (12) months thereafter, if not prolonged upon mutual consent.

Under the agreement, the parties will pool their expertise in research and development, sales, engineering for products, systems and technologies and marketing, and will exchange experts in order to share know-how. The co-operation agreement contains an IP rights clause and a non-compete clause. The co-operation agreement does not contain any governing law clause. Each party shall bear its own costs and expenses in respect of the implementation of the agreement. The co-operation agreement does not include a general compensation model. The compensation will be agreed on individually from project to project.

Currently two loan agreements of MSEK 1,8 and MSEK 0,5 (not yet signed, currently under preparation) are signed with Absolicon to finance continued operations. The loan can be extended up to MSEK 3,0. The loans have a revers promissory note and an interest rate of 1%. They have to be repaid on request, latest after three years. The repayment should not have a negative effect for the operational business. Industrial Solar expects to transfer existing projects from the old to the new company and receive new projects and incomes to continue the business. The loans are not intended to be paid back using capital from the current issue, but from future profits on activities or using stocks.

Issuing agent

The issuing agent in relation to the issuing of the new shares and warrants as described in this Memorandum is Eminova Fondkommission AB, Biblioteksgatan 3, 111 46 Stockholm, Sweden. Eminova assumes no responsibilities of any kind related to investments made in the Company, or for any information included in this Memorandum. Eminova owns no securities and holds no other interests in the Company, but may provide similar services to the Company in the future.

Investments exceeding five percent of the offering

The Board is not aware of any intentions by any investor to subscribe for five percent or more of the current issue, in addition to those owners who have subscribed for shares under the terms presented elsewhere in this Memorandum.

Permits and licences

The Company is not dependent on any licences to conduct its current business.

Patents held

Industrial Solar has not filed for any patents due to an internal policy not to disclose any information regarding inventions for which infringements cannot easily be proven. In addition, Industrial Solar has extensive know-how in the design of Fresnel collector technology and turnkey solutions which is not publicly disclosed.

Tax issues

Transactions in Industrial Solar's securities may result in tax consequences for the holder. Holders of securities in the Company are advised to seek advice from tax advisors regarding the tax consequences that may arise in each individual case. For individuals who are unlimited taxpayers in Sweden, preliminary tax on dividends is 30 percent. The preliminary tax is normally managed by Euroclear, or by the trustee if the shareholdings is registered at a trustee.

Industrial Solar is not responsible for withholding tax.

ARTICLES OF ASSOCIATION FOR INDUSTRIAL SOLAR HOLDING EUROPE AB

BOLAGSORDNING - ARTICLES OF ASSOCIATION

INDUSTRIAL SOLAR HOLDING EUROPE AB

Org.nr 559110-3972

Note: the legally binding text is in Swedish and the English translation is only offered as a service to the reader.

Firma / Name of company

Bolagets firma är Industrial Solar Holding Europe AB. Bolaget är publikt (publ).
The corporate name of the Company is Industrial Solar Holding Europe AB. The Company shall be public (publ).

Styrelsens säte / Registered office of the company

Styrelsen har sitt säte i Härnösand.
The registered office of the Board of Directors is in Härnösand.

Verksamhet / Object of the company

Bolaget ska, direkt eller indirekt, bedriva utveckling och tillverkning av utrustning för förnyelsebar energi. Service och projektering, försäljning och finansiering av projekt inom förnyelsebar energi. Handel med värdepapper.

The Company shall, directly or indirectly, conduct the development and manufacture of renewable energy equipment; the service, design, sale and financing of renewable energy projects; and trading in securities.

Aktiekapital och antal aktier / Share capital and number of shares

Aktiekapitalet utgör lägst 500 000 kronor och högst 1 000 000 kronor. Antalet aktier ska vara lägst 5 000 000 stycken och högst 20 000 000 stycken.

The minimum share capital is SEK 500,000 and the maximum share capital is SEK 1,000,000.

The minimum number of shares is 5,000,000 and the maximum number of shares is 20,000,000.

Styrelse / Board of Directors

Styrelsen ska bestå av 3–10 ledamöter med högst 10 suppleanter.

The Board of Directors shall consist of 3-10 directors with not more than 10 deputy directors.

Revisorer / Auditors

Bolaget ska ha 1–2 revisorer med högst 2 revisorssuppleanter eller ett registrerat revisionsbolag.

The Company shall have 1-2 auditors with maximum 2 deputy auditors or one registered auditing company.

Kallelse till bolagsstämma / Notice to attend general meetings

Kallelse till bolagsstämma ska ske genom annonsering i Post- och Inrikes Tidningar och genom att kallelsen hålls tillgänglig på bolagets webbplats. Samtidigt som kallelse sker ska bolaget genom annonsering i Dagens Industri upplysa om att kallelse har skett.

Kallelse till bolagsstämma ska ske tidigast sex och senast två veckor före stämman.

Notice to attend a general meeting shall be advertised in Post- och Inrikes Tidningar (The Official Swedish Gazette) and on the Company website. At the time of notice, information about the notice shall be advertised in Dagens Industri.

The notice shall be published at the earliest six weeks and at the latest two weeks before the annual meeting.

Öppnande av stämma / Opening of the meeting

Styrelsens ordförande eller den styrelsen därtill utser öppnar bolagsstämman och leder förhandlingarna till dess ordförande vid stämman valts.

The annual general meeting shall be opened by the Chairman of the Board or whomsoever is appointed by the Board of Directors, who shall oversee proceedings until the annual meeting has elected a chairman of the meeting.

Årsstämma / Annual general meeting

Årsstämma hålls årligen inom sex månader efter räkenskapsårets utgång.

På årsstämma ska följande ärenden förekomma.

1. Val av ordförande vid stämman, Election of chairman of the meeting
2. Upprättande och godkännande av röstlängd, Preparation and approval of the voting list
3. Godkännande av dagordning, Approval of the agenda
4. I förekommande fall, val av en eller två justeringspersoner, Election of one or two persons to verify the minutes
5. Prövning av om stämman blivit behörigen sammankallad, Determination of whether the meeting has been duly convened
6. Föredragning av framlagd årsredovisning och revisionsberättelse samt, i förekommande fall, koncernredovisning och koncernrevisionsberättelse,
7. Beslut om Resolutions on
 - a - fastställande av resultaträkning och balansräkning, samt, i förekommande fall, koncernresultaträkning och koncernbalansräkning, adoption of the profit and loss account and the balance sheet
 - b - dispositioner beträffande vinst eller förlust enligt den fastställda balansräkningen, allocation of the Company's profits or losses according to the balance sheet adopted
 - c - ansvarsfrihet åt styrelseledamöter och verkställande direktör när sådan förekommer, discharge from liability of the members of the Board of Directors and the managing director
8. Fastställande av styrelse- och revisorsarvoden, Determination of remuneration for the Board of Directors and for the auditor
9. Val av styrelse och revisionsbolag eller revisorer, Election of Board of Directors and election of auditor
10. Annat ärende, som ankommer på stämman enligt aktiebolagslagen eller bolagsordningen. Election of Board of Directors and, as the case may be, election of auditor

Räkenskapsår / Financial year

Bolagets räkenskapsår ska omfatta tiden den 1 januari – den 31 december.

The Company's financial year shall be 1 January – 31 December.

Avstämningsförbehåll

Bolagets aktier skall vara registrerade i ett avstämningsregister enligt lagen (1998:1479) om värdepapperscentraler och kon-
toföring av finansiella instrument.

The Company's shares shall be registered in a central securities depository register in accordance with the Act on Central Securities Depositories and Financial Instruments Accounts Act (1998:1479).

Antagna 2018-09-19; Adopted 2018-09-19

Industrial Solar Holding Europe AB
Fiskaregatan 11
87133 Härnösand / Sweden

Tel: +49 761 767111-0

www.industrial-solar.se
info@industrial-solar.de

INDUSTRIAL  SOLAR
renewables onsite